



HOME IMPROVEMENTS

Camden Planning Guidance

January 2021

TABLE OF CONTENTS

INTRODUCTION	4	HOME IMPROVEMENTS	34
Purpose of the guidance		MATERIALS	36
CAMDEN CONTEXT	6	EXTENSIONS	38
Your home and your surroundings		Ground extensions	
		• Rear	
		• Side and front	
PLANNING PROCESS	8	Roof extensions	
User journey		• Dormers	
Types of work & Planning process		• New roof level	
Other consents to consider		• Balconies	
KEY PRINCIPLES	16	EXTERNAL ALTERATIONS	56
HOME	18	Windows and doors	
SUSTAINABILITY	20	Walls	
NEIGHBOURS	30	External pipework	
COMMUNITY	32	Roof	
		Rooflights	
		INTERNAL ALTERATIONS	62
		Internal layouts	
		GARDENS	68
		Landscaping	
		Front, rear & side gardens	
		Boundary treatments	
		Garden storage	
		Outbuildings	
		APPENDICES	78
		Appendix 1	80
		Appendix 2	82

The illustrations provided throughout the document are for illustrative purpose only and would not be binding upon the Council, nor prejudice any future planning application decisions made by the Council.

This guidance does not provide information on listed buildings. We recommend you seek detailed specialist advice from a heritage consultant and the Local Authority.

INTRODUCTION

PURPOSE OF THE GUIDANCE

Camden Vision 2025 seeks to ensure that all Camden residents are able to live a healthy, independent life, have a place to call home, are part of safe, strong and open communities, whilst enjoying a clean, vibrant and sustainable place.

This guidance supports the Council's vision by providing information about how you can adapt and improve your home as your circumstances change. The planning process can often be seen as a major obstacle to home improvements, with many residents choosing to move house rather than carry out works to their home. This guidance seeks to assist residents, you, to navigate their way through the planning process and adapt their homes to respond their needs. It explores what can be done without permission and how you can improve the chances of a successful planning application. Alongside this we have sought to help you think about what role you can play in tackling climate change in the Borough. Lots of small changes within your home can make a big impact on you, the Borough and future generations.

Tip Boxes throughout this document highlight important information relevant to you.

This guidance aims to help you to:

- **Better appreciate the internal space of your home;**
- **Understand what changes to your home would improve your living conditions;**
- **Flexibly adapt your home in response to changes within your household over time, such as growing families;**
- **Understand if your proposal would require planning permission and what are the main considerations that are taken into account in the assessment of planning applications;**
- **Achieve high quality and sustainable design changes to your home which may reduce your bills and benefit you and your household long term;**
- **Tackle the climate crisis by reducing your home's CO2 emissions through retrofitting and enhancing biodiversity;**
- **Ensure your home supports your health and wellbeing; and**
- **Empowers you to make informed decisions about your future.**

LOCAL PLAN, POLICIES, AND GUIDANCE

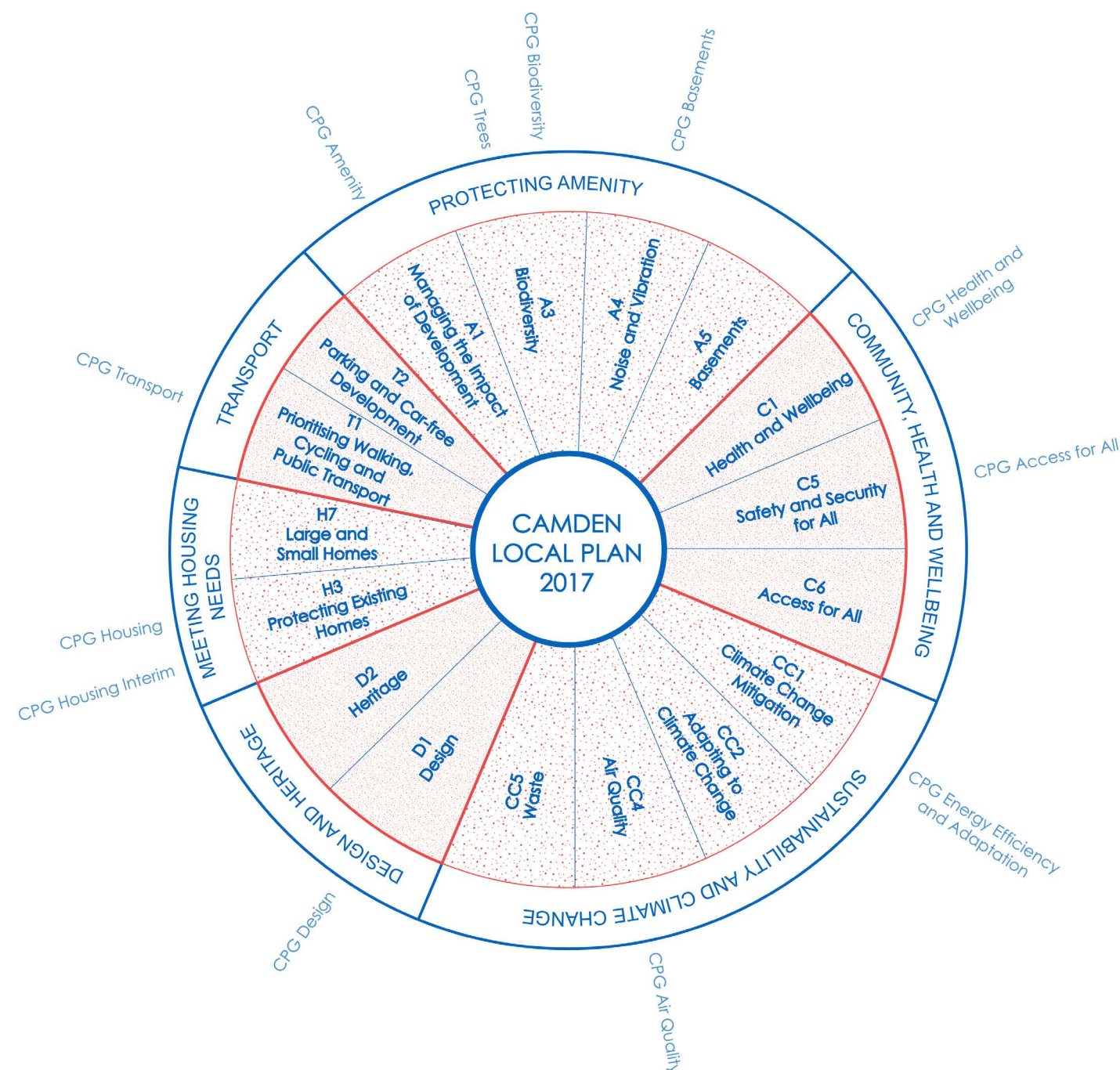

The Local Plan, Neighbourhood Plans, Camden Planning Guidance and Conservation Area Appraisals documents contain a wealth of information, which are produced to guide the decision making of the local planning authority. This guidance seeks to highlight the key parts of these documents which relate to alterations and

extensions to residential/domestic properties in order to provide a more useful tool for residents. Throughout this document, you will be directed to other guidance (CPGs) on certain subjects to help you make an informed decision about your proposed home improvement.

CAMDEN CONTEXT

YOUR HOME AND SURROUNDINGS

Camden is a diverse and dynamic Borough with rich built and natural environments. The Borough contains many neighbourhoods each with their own distinctive identity and characteristics. Its architectural heritage is vast and the Borough has many buildings and places of architectural or historic importance.

The southern area of the borough is part of Central London and, along with a rich mix of offices, theatres, museums, universities and other institutions of national and international significance, it also includes residential streets and mews in Georgian Bloomsbury and Fitzrovia, as well as large estates like the Brunswick Centre.

Further north the character changes with many residential areas and neighbourhoods comprising of a mix of residential building types, such as Camden Town, Hampstead and Highgate, and larger estates and self-contained accommodation in areas such as Swiss Cottage, West Hampstead and Kentish Town.

The Borough has a rich architectural heritage with many special places and buildings reflecting Camden's history. There are 39 Conservation Areas, covering almost 50% of the land area, which recognise their architectural or historic interest and their character and appearance. Further guidance on the character of each Conservation Area is included in [Conservation Area Statements](#), [Appraisals](#).

Every building within the Borough is unique and contributes to the overall identity of each street and area of Camden. This is the reason why taking account of the wider streetscene and community context is so important when altering your home.

It is a significant challenge for Camden to adapt to population growth while improving the quality of life of residents, preserving our valued places, and promoting high quality design.

Throughout Camden there are areas characterised by their main function and purpose such as high streets, local centres, converted factories/studios, Georgian housing, Victorian housing, 20th century housing, post-war housing, 21st century housing, and tall buildings.



Clockwise:
Photo 1
Photo 2
Photo 3
Photo 4
Photo 5
Photo 6

PLANNING PROCESS

There are a multitude of things to consider before starting works to your home. One of the first steps is to be clear what the benefits of the proposed changes to your household are, and secondly, if these changes would require planning permission, or not.

In order to establish if planning permission is required, it is important you gain some awareness of the planning process by exploring what are the Council's policies and guidance relevant for your project. This guidance aims to build your awareness so you know what the next steps in achieving your desired home improvement are.

USER JOURNEY

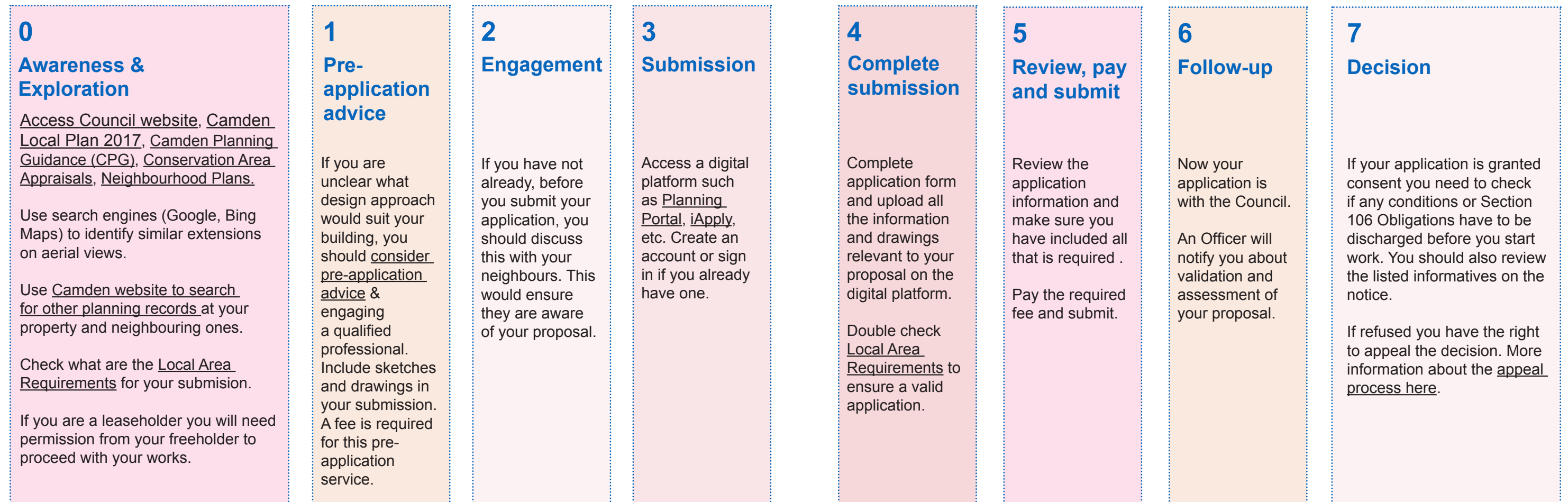

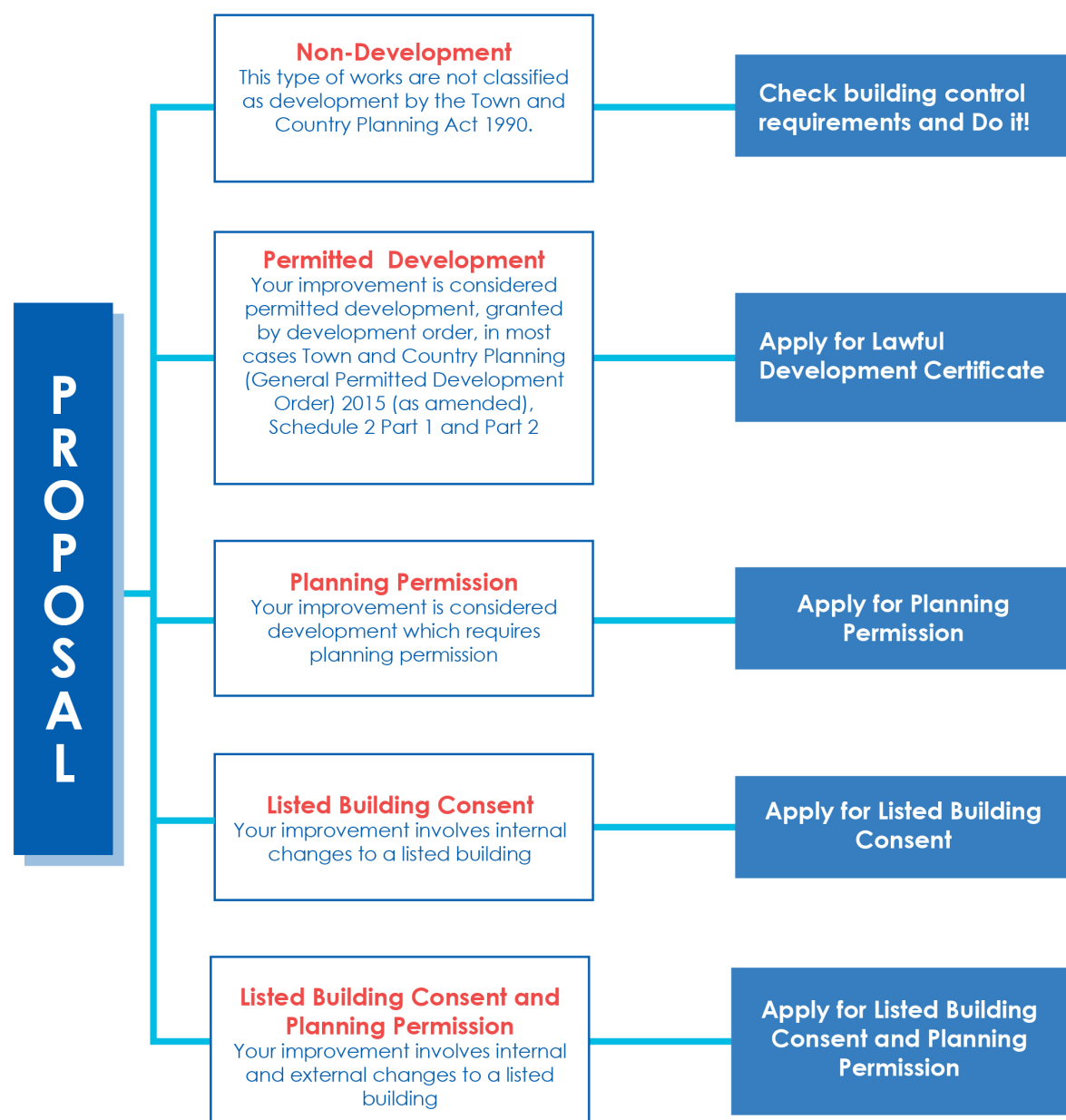

This guidance does not provide any further information on listed buildings, for which you are encouraged to get detailed specialist advice from a heritage consultant, Historic England and subsequently Council Officers through pre-application advice, when considered necessary.

You are advised to apply for Lawful Development Certificates, Planning Permissions or Listed Building Consents electronically.

NON-DEVELOPMENT

Non-development refers to works of maintenance and/or like for like replacements of building features. These types of work are not classified as development by the Town and Country Planning Act 1990 (as amended) and therefore do not require planning permission.

PERMITTED DEVELOPMENT

Rules, known as ‘permitted development’ rights, applied nationally, allow you to carry out certain works without needing to apply for planning permission, only if specific limitations and conditions are met. If you live in a single family dwelling, then it is likely to have permitted development rights. Properties within Conservation Areas do have access to certain rights. These rights generally do not apply:

- to flats or properties converted into flats;
- to listed buildings;
- where permitted development rights have been removed by an Article 4 Direction, most likely within Conservation Areas;
- where permitted development rights were removed as part of previous planning permissions on certain buildings.

Permitted development rights are supported by the Town and Country Planning (General Permitted Development) (England) Order 2015 (as amended), in short GPDO. For more details see Permitted Development Rights for Householders: technical guidance prepared by the Government. These are subject to change therefore it is best to check this guidance regularly by following [this link](#).

We strongly recommend you to apply for a Lawful Development Certificate and receive formal confirmation from the Council that your proposal is lawful under the GPDO, and planning permission is not required.

ARTICLE 4 DIRECTIONS

The Local Planning Authority can remove certain permitted development rights by issuing Article 4 Directions.

In relation to dwellings and flats, Article 4 Directions are aimed at ensuring that historic features are preserved and, where possible repaired rather than replaced.

Find more information about [Article 4 Directions here](#).

PRIOR APPROVAL

There are certain permitted development rights for properties outside Conservation Areas, which allow for larger single storey rear extensions, subject to limitations and conditions by Government. For these types of extensions you will need to apply for Prior Approval: Larger home extension. A consultation process will be undertaken with adjacent neighbours, to ensure their amenity would not be harmfully affected by the proposals. For further information on prior approval follow [here](#).

PLANNING PERMISSION

If the works do not fall under permitted development or prior approval, it is likely they will require planning permission. You will need to submit a planning application including existing and proposed drawings along with any other supplementary documentation, which is outlined on the Council’s website.

The Council recommends engaging with a qualified professional as early as possible in the design process. He/she can prepare and submit the application on your behalf. Qualified planning consultants and architects can be found through [RTPI](#) or [RIBA](#).

PRE-APPLICATION

If the works require planning permission and you are unsure of the design or just want to clarify certain aspects of your proposal, you are encouraged to engage with Council Officers prior to submission. The Council offers a [pre-application service](#) for an associated fee.

LISTED BUILDING CONSENT

Any works to a Listed Building whether it's internal or external will require Listed Building Consent. This guidance does not provide any further information on listed buildings, for which you are encouraged to get detailed specialist advice from a heritage consultant, [Historic England](#) and subsequently Council Officers through pre-application advice, when considered necessary.

Be aware, if you undertake works without planning permission and they are not permitted development, the Council's Enforcement team could take enforcement action against you.

OTHER APPROVALS/CONSENTS TO CONSIDER

Whichever option you choose, please note that a separate **Building Control** application will most likely be required. You should contact [Camden Building Control](#) who will confirm if your proposed works are exempt from building regulations.

Be mindful that any works or impacts to trees on your property may also require a separate [tree application](#), particularly if it has a **Tree Preservation Order** or your home is in a Conservation Area.

If your proposal involves works to party walls, these are covered by [Party Wall Act 1996](#) and are not considered by planning legislation. You should discuss with a Party Wall surveyor.

We would also encourage homeowners adjacent to the Regents Canal to contact the Canal and River Trust and refer to their Code of Practice for works affecting the [Canal and River Trust](#).

You should also consider checking that your works do not involve any [Thames Water Assets](#) for which you may require their consent.

When you apply for planning permission it is important to follow the detailed advice in this document. The planning officer will use this guidance when assessing your application.



Photo 7

CONSERVATION AREAS & ARTICLE 4 DIRECTIONS HERITAGE AND CONSERVATION NEIGHBOURHOOD PLANS

You can check if your property is listed or in a Conservation Area on the [Council website here](#) or type in Conservation Areas in the search bar on the [website](#).

CONSERVATION AREAS

-  Conservation Area
-  **Conservation Area with Article 4**

1. Alexandra Road Estate
2. Bartholomew Estate
- 3. Belsize**
4. Bloomsbury
5. Camden Broadway
6. Camden Square
7. Camden Town
8. Charlotte Street
- 9. Dartmouth Park**
10. Denmark Street
11. Elsworthy
12. Eton
- 13. Fitzjohns/Netherhall**
14. Fitzroy Square
- 15. Hampstead**
16. Hanway Street
17. Harmond Street
18. Hatton Garden
19. Highgate
20. Holly Lodge Estate
21. Inkerman
22. Jeffreys Street
23. Kelly Street
24. Kentish Town
25. Kings Corss/ St. Pancras
26. Kingsway
27. Mansifeld
28. Parkhill and Upper Park
- 29. Primrose Hill**
30. Priory Road
31. Redington/Frogna
32. Regent's Canal
33. Regent's Park
34. Rochester
35. Seven Dials Estate
- 36. South Hampstead (formerly Swiss Cottage)**
- 37. South Hill Park Estate**
38. St. John's Wood
39. West End Green
40. West Kentish Town

- Article 4**
- 9. Only for no. 33 York Rise
 - 13. Only for the Cottage, 67 Fitzjohns Avenue
 - 37. Only for nos. 32-66 (even) and 72-90 (even) South Hill Park

NEIGHBOURHOOD PLANS

-  Neighbourhood Plan

- A. Dartmouth Park
- B. Fortune Green and West Hampstead
- C. Kentish Town
- D. Hampstead
- E. Highgate
- F. Redington and Frogna

-  Conservation Area
-  Article 4 in Conservation Area
-  Neighbourhood Plan
-  Green Spaces
-  Regent's Canal
-  Railway
-  Camden Borough boundary
-  Underground station

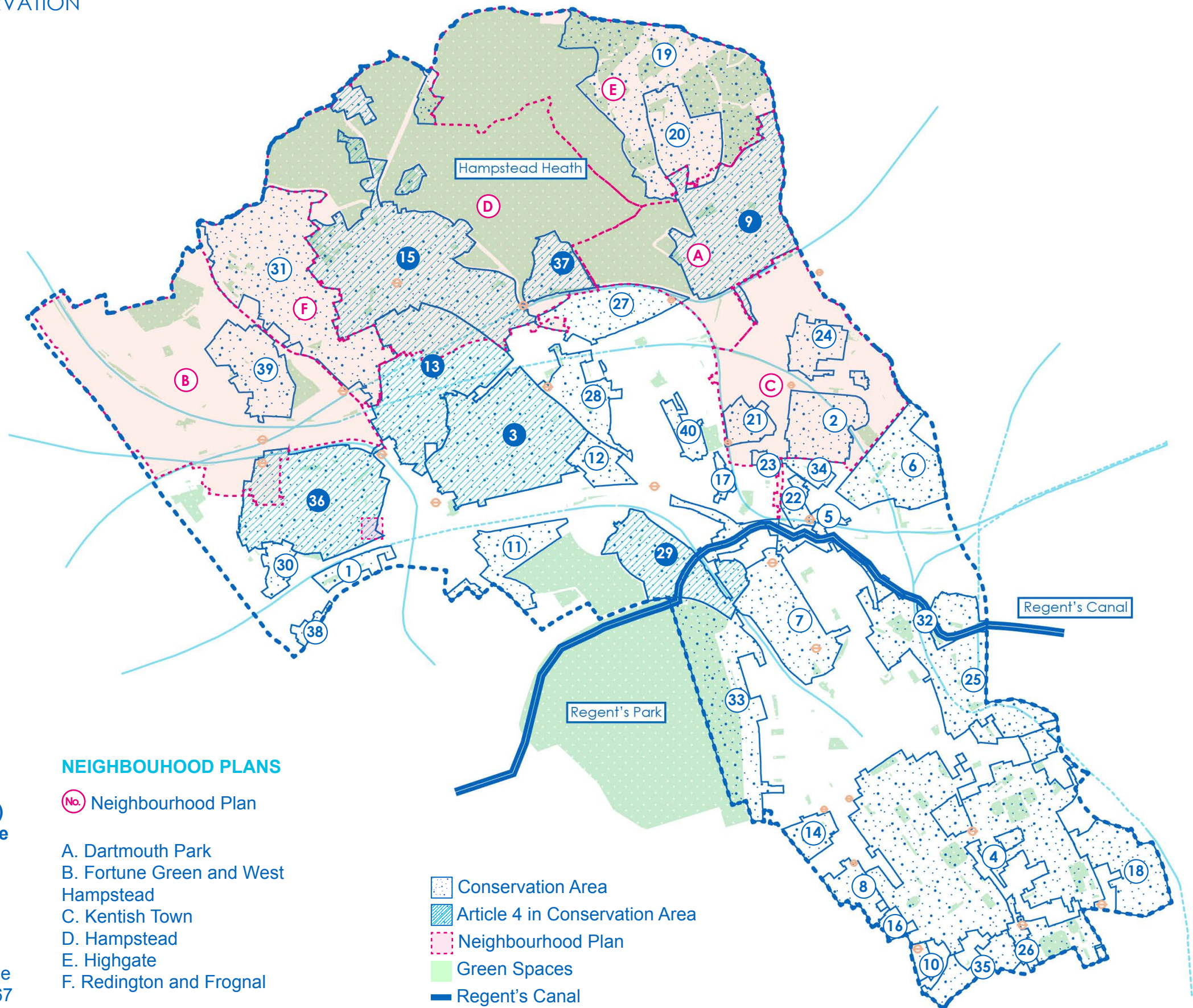

KEY PRINCIPLES

Throughout this document you will find a number of measures to guide the development of your home improvement within the key principles of home, sustainability, neighbours and community. The principles are interlinked and when applied cumulatively they will contribute to achieving high quality development which improves your living accommodation, responds to changes within your household, is sustainable and resilient, respects your neighbours and community and does not harm the natural and built environment.



HOME

These standards are to ensure your living conditions are improved by the proposed changes to your home. You should consider these along with the other key principles.



SUSTAINABILITY

There are certain elements that you can introduce along with the proposed changes to your home to make it more resilient, increase its energy efficiency, and reduce your bills and carbon footprint. You should consider these along with the other key principles.



NEIGHBOURS

These standards are to ensure that the proposed changes to your home would take into consideration the neighbouring properties and ensure the amenity of your neighbours would not be harmfully affected.



COMMUNITY

These standards encourage you to appreciate your property belonging within a wider community and therefore seeks to ensure that your proposal does not adversely impact the streetscene, local neighbourhood, and the wider built and natural environment surrounding your home.

HOME



These measures are to ensure your living conditions are improved by the proposed changes to your home. They should be closely adhered to for all residential extensions or alterations except in circumstances where the proposal would contravene any of the other key principles concerned with neighbours and the wider community.

A person's home can provide them with security, control, belonging, identity, and privacy, among other things. The things that make a home 'perfect' vary from person to person and can change with time and circumstance – a new child; children getting older; an elderly parent moving in; increased home working. When making a change to your home it is really important to consider why you are making the change, establish what currently works or doesn't work in your home and how you can alter or extend it so that it better meets your needs.

It is important to note that you don't always need to think big, as small changes can have a big impact on your living conditions. The depth of rooms, internal floor to ceiling height and window opening positions and dimensions, all have a direct impact on the way the rooms are perceived, how they make you feel and will influence the way you interact with it. The position and type of furniture is also an important factor in shaping the internal space of your home, which could make it more spacious or more restrictive.

The home is not just confined to internal spaces. The external space around your home holds significant value in terms of visual and physical amenity, sustainability and biodiversity. It supports outside activities, helps you relax and enjoy the surrounding

area, whilst also providing space to extend your home, to add other garden structures such as outbuildings and storage. The extent of built areas around your home needs to be carefully balanced with the benefits of the outside space and greenery. You can find more information about changes to garden space in Gardens chapter.

Regardless of the type of alteration or extension you are planning there are some basic principles that you should consider:

- **Respect and be complementary to the original character of the existing building;**
- **Design spaces to be functional and adaptable for a range of uses, such as social gatherings, rest and relaxation;**
- **Ensure rooms achieve a good quality internal environment that benefit from adequate natural daylight, outlook and ventilation;**
- **Ensure that the space is usable and accessible to people with varying abilities;**
- **Consider sustainable measures within the design that maintain and improve your living conditions;**
- **Ensure extensions and alterations are safe and secure.**

GOOD PRACTICE BASIC PRINCIPLES

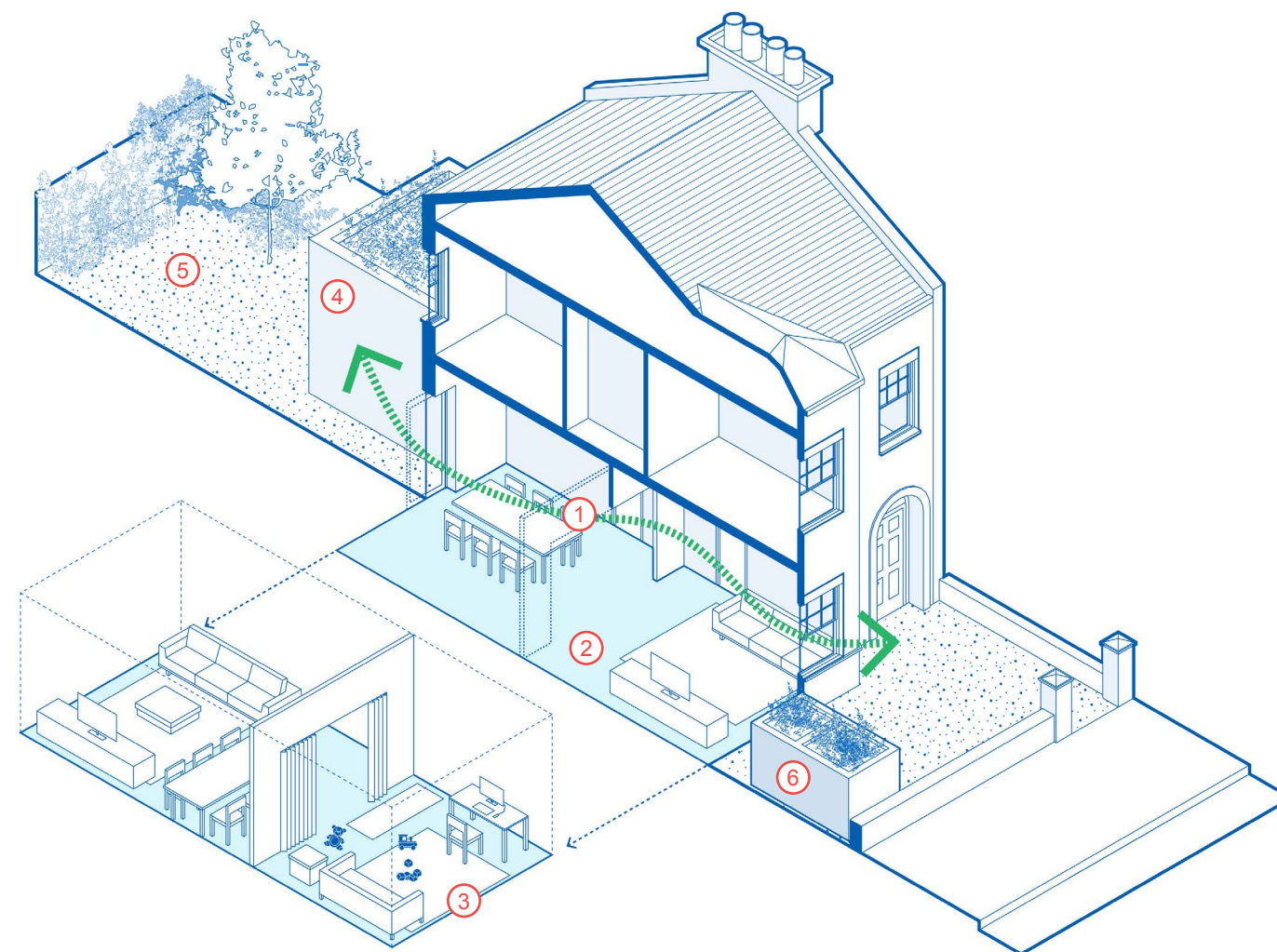

CONSIDERATIONS

1. Natural ventilation between spaces and dual aspect with good internal environment
2. Common internal layout
3. Adapted internal layout to various needs, such as: working from home, exercise, play
4. Subordinate rear extension
5. Adequate garden and green space retained
6. Storage space

SUSTAINABILITY



There are certain measures that you can introduce along with the proposed changes to your home to make it more resilient, increase its energy efficiency, reduce your bills and carbon footprint. You should consider these along with the other key principles.

A way in which you can improve your living conditions is to make your home more energy efficient. Home alterations and extensions are important because they can provide additional living space but crucially, they can also improve the overall energy efficiency of your home. An energy efficient alteration or extension can be a cost effective approach, as the additional cost can be quickly recovered in reduced fuel costs.

In Camden around 25% of carbon emissions come from our homes ([Carbon Descent 2019](#)). Therefore, increasing the energy efficiency of the existing building stock in the Borough is a critical component of reaching a Net Zero Carbon future.

There are various actions the Council is undertaking in response to the climate emergency, and these can be found in the [Climate Action Plan](#). It is really important to Camden Council that we all play an active part in addressing climate change.

The way a building responds to climate change depends on a variety of factors including its location, orientation, design, construction, engineering services and the way it is used, managed and maintained. Whilst some of these are fixed, others can be altered over time which allows you to influence energy use and effectiveness of energy saving measures.

This key principle highlights sustainable measures that you could consider incorporating into your home improvement. These range from easy fixes to more complex measures as part of a deep retrofit approach. For more broad information about this please see [CPG on Energy Efficiency and Adaptation](#).

Regardless of the type of alteration or extension you are planning, there are some basic standards you should consider:

- **The orientation of your home and where the most appropriate location for an alteration/extension would be;**
- **The size and design of your proposal, a larger extension may not always be the best solution, so consider your internal and external space requirements and the climate impact, such as maintenance costs (heating), use of materials and their embodied carbon, and the resulting quality of the external/garden space;**
- **The quality of materials contributes to the overall efficiency and long term cost savings, particularly important for insulation and new windows/doors;**
- **The installation of insulation and inclusion of renewable energy measures such as photovoltaics, solar thermal, and heat pumps can improve the comfort of your home, reduce your carbon footprint and overall bill costs;**
- **The incorporation of green infrastructure as insulating material but also to improve the biodiversity, overall visual appearance and your wellbeing.**

All measures include information about:

- **Cost/payback** £
- **Improvement level** ↗
- **Disruption** ⚠

HOME ENERGY EFFICIENCY GREENING AND BIODIVERSITY MEASURES

- 1. NATURAL COOLING
- 2. ROOF INSULATION
- 3. PIPES AND SERVICING
- 4. DRAUGHT PROOFING
- 5. LIGHTS AND APPLIANCES
- 6. HEATING CONTROLS
- 7. WALL INSULATION
- 8. GREEN ROOF

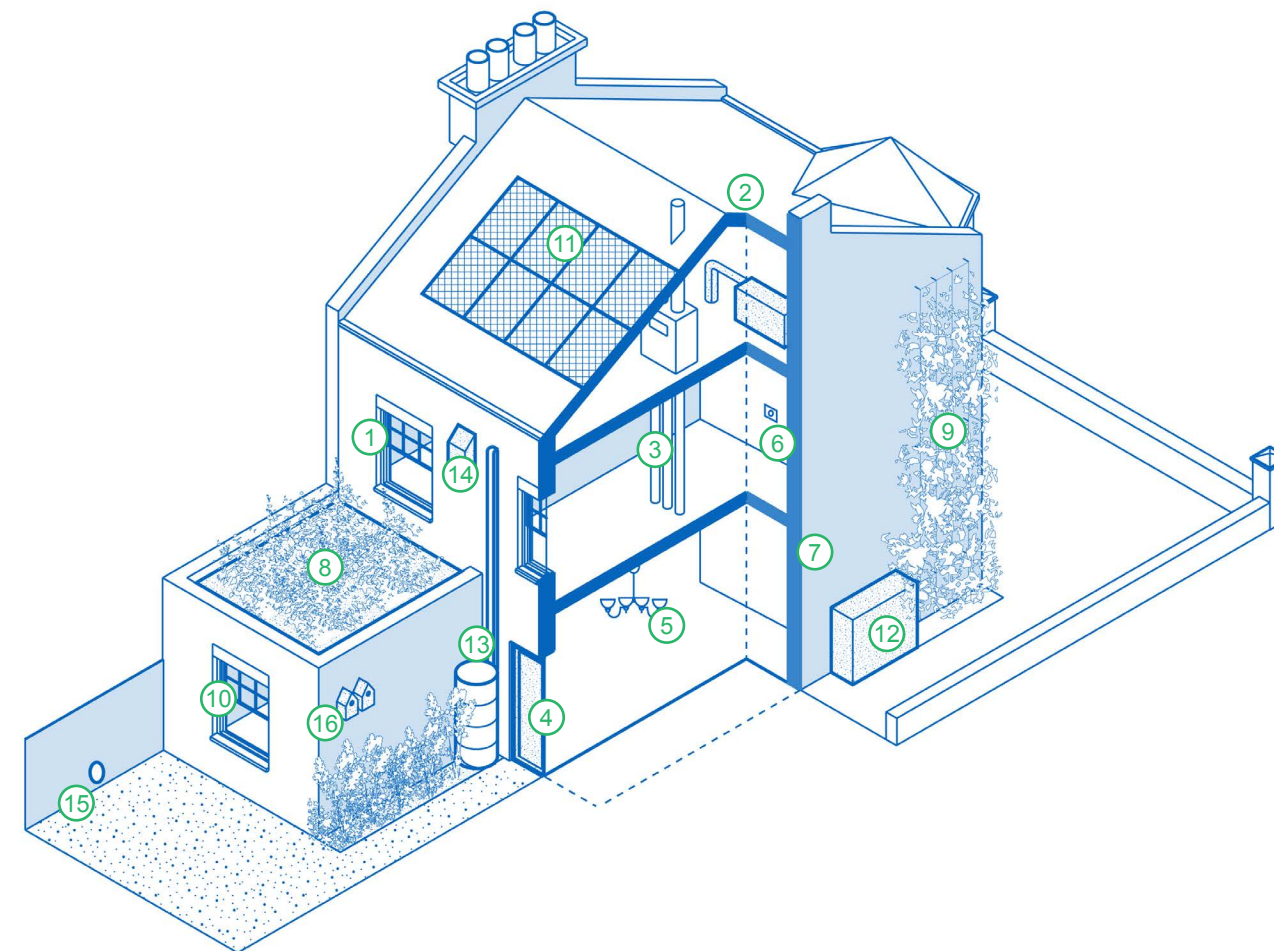

- 9. VERTICAL GREENING
- 10. DOUBLE/ TRIPLE GLAZING
- 11. SOLAR PANELS - PV OR THERMAL
- 12. SUSTAINABLE HEATING
- 13. WATER TANK
- 14. BAT BOX
- 15. WILDLIFE GAPS
- 16. BIRD BOXES

ROOF INSULATION



Approximately ¼ of heat in an uninsulated house is lost through its roof. Roof insulation is generally the most cost effective way to reduce energy use.

You can insulate your roof in two ways:

- by using loft insulation blankets, also known as ‘quilts’ which you can do yourself. As a guide, loft insulation should be around 270mm (about 1 foot) thick if using mineral wool to be effective; or
- with blown insulation which uses specialist equipment to blow loose, fire-retardant material into the loft.

Flat roofs can be insulated too. This can be done by insulating the roof from above as part of re-roofing work. If the roof does not need replacing a layer of rigid insulation board can be fitted on top of the roof’s weatherproof layer or directly on top of the timber with a new weatherproof layer on top.

Green roofs are also a good way to insulate the roofs, see Greening and Biodiversity section below.

Your extension should be insulated to the Building Regulations standards. Why not ask your builder for a quote to insulate the rest of your home at the same time?

LOFT INSULATION



ROOM IN ROOF INSULATION



WALL INSULATION



Most homes that were built in the 1930s have cavity wall construction which means there is an exterior wall with a second wall built next to it. The space between the two walls is called the cavity and this is filled with insulation material. Insulating your cavity walls will help to heat your home more efficiently and can reduce heat loss by up to 60%.

For homes built before the 1930s, it is likely that they will have solid external walls. Solid walls have no gap, which allow nearly twice as much heat to pass through them if they are un-insulated. Solid walls can be insulated either with internal insulation or external insulation.

External wall insulation involves putting an insulating layer (about 100mm thick) on the outside of your home and is usually covered with brick slips or a render. Generally, external wall insulation could significantly affect the character and appearance of buildings, groups of buildings and wider area. However, there are cases where external insulation could fit in with the surroundings. This type of alteration is likely to require planning permission. You should firstly consider internal insulation and if not feasible, consider other energy efficiency measures.

Internal wall insulation uses insulation boards or a wooden frame filled with insulation attached to the inside of your walls. This type of alteration would not require planning permission.

CAVITY WALL INSULATION



INTERNAL WALL INSULATION



EXTERNAL WALL INSULATION



DRAUGHT PROOFING



Draught proofing is a cost effective way to reduce heat loss. Draughts are most common around doors and windows, between floor boards, behind skirting boards and anywhere there is a pipe or cable going through to the outside of the building.

Draught free homes are comfortable at lower temperatures so you’ll be able to turn down your thermostat, which could save approximately £55 per year. Draught proofing is really easy to install and you can even do it yourself.

If you have an existing extension, or are planning to build one, effective draught proofing should be installed between the existing building and the extension.

Floor insulation. If there are any gaps between floorboards and skirting boards, you can reduce heat loss by sealing them with a regular tube sealant. It is also very useful to insulate underneath the floorboards at ground floor level.

DRAUGHT PROOFING



GLAZING



Windows let light and heat into a building, but they can also let a lot of heat out when temperatures are colder outside than inside. If you are replacing windows or building an extension, thermally efficient glass will provide more effective insulation than older windows.

Consider the amount and orientation of glazed openings (windows, doors, and rooflights):

- **Southerly orientation** - a large proportion of glazing will likely cause overheating in the summer (unless they are effectively shaded), and heat loss in the winter (increasing heating costs). Rooms with a southerly orientation should be designed with shaded glazing or with other shading materials (blinds, shutters, trees, vegetation) and good ventilation.
- **Northerly orientation** - minimize window size to reduce heat loss, as they do not trap solar gains.
- **Daylighting** - consider the size of windows to maximise daylighting (reducing the need for artificial lighting) but limit overheating and heat loss.

Please also consider the impacts of light pollution on adjoining properties with roof glazing.

UPGRADING WINDOWS / NEW WINDOWS (SINGLE TO DOUBLE GLAZING)



LIGHTING AND APPLIANCES



Lighting and other energy using equipment and appliances should run to use as little energy as possible. LED lights use significantly less energy but consider how many are required. Daylight sensors may help minimise lights being left on unnecessarily. External lighting should be kept to a minimum to protect biodiversity.

HEATING AND HOT WATER



Consider ways to reduce the demand for heating and hot water first by insulating your home as much as possible and installing low flow taps and showers.

Radiators. If you have a radiator on an outside wall you can reflect heat back into the room (rather than being lost through the wall) by adding an insulating panel with reflective material.

Pipework. Think about your boiler/heat pump location to minimise the distance hot water needs to travel when you turn on a tap (should be close to the kitchen and bathrooms) and ensure all pipes are well insulated to keep the water hot and reduce overheating of your home in summer.

Heating Controls. Install heating controls that allow control of the temperature in different parts of your home. You can set a timer or control them manually.

LIGHTING



PIPES / BOILER TANK INSULATION



RENEWABLE ENERGY



Buildings can also reduce their energy consumption by generating their own energy in the form of heat or electricity using low carbon and renewable technologies which use little or no energy.

Solar water heating. Solar panels are fitted to the roof to collect heat from the sun to heat up water stored in a hot water cylinder. They are appropriate for large family homes that use large quantities of hot water.

Solar PV panels. Panels convert light energy into electric energy and need only daylight to work, rather than bright sunshine. Solar PV panels are most efficient on a roof or wall that is south facing and are not overshadowed. These can also work well on top of a green roof because the cooler temperature created locally by the vegetation improves the efficiency of the solar panel.

The cost of a PV system depends on its size. Camden Climate fund can support some of PV system costs. You can find more information about this on the [Camden Climate Fund webpage here](#).

Please complete the checklist of measures in Appendix 1 and submit with your planning application to demonstrate what you have considered.

SOLAR PV (ELECTRIC)



AIR SOURCE HEAT PUMP



GROUND SOURCE HEAT PUMP



Other tips you should consider when installing solar panels, to reduce their impact on the streetscene, and wider area:

- Ensure panels are spaced evenly on the roof slope and not in an irregular pattern.
- Ensure the position of the panels would retain even distances to the roof margins (ridge, eaves, party walls) and/or wall margins;
- Place panels behind parapets or roof features where possible (such as chimneys), and where these features do not cause shading issues;
- Run cabling in a position to minimise visibility from the street and adjacent properties;
- Use cabling and cable ducts which are in keeping with the colour of the building exterior (such as black for brick building, white for white rendered building).

Green roofs are compatible with solar PV. The vegetation provides thermal regulation for PV panels. The planting specifications should be tailored to realise the benefits most suitable for the site (CPG EE and Adaptation).

If your home improvement work requires scaffolding, such as a loft conversion, this would be an ideal time to install solar panels. Scaffolding is a significant part of the solar installation costs, so combining it with other works could make them much more cost-effective.

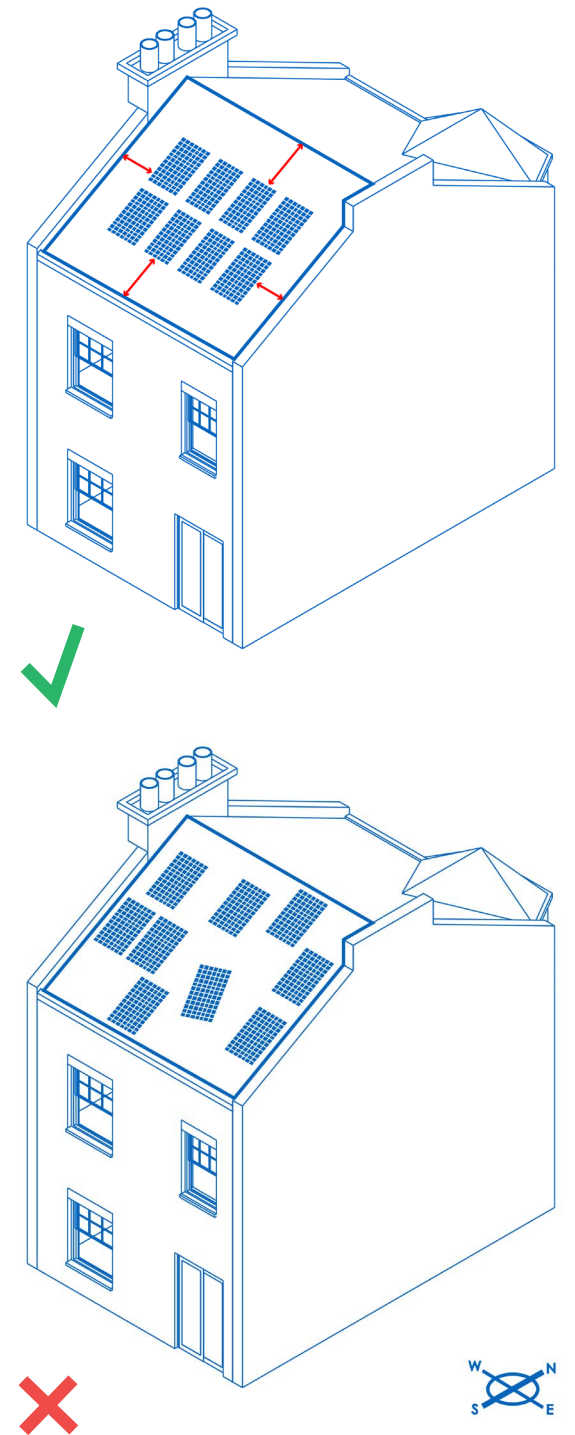

Photo 8

Heat pumps. Heat pumps are most efficient in buildings that are well insulated and draught proofed. If you are planning to fully retrofit your home this would be the best method to provide heating. The whole system is powered by electricity, which is becoming less carbon intensive but if it's not a renewable source the heat pump will still generate carbon emissions; however, this will be less than other conventional types of heating. The types of heat pump suitable for single domestic properties are:

- Ground source heat pump; or
- Air source heat pump.

Ground source heat pumps use a loop of pipes filled with water and antifreeze buried in the ground to absorb this heat and transfer it through a heat exchanger into the heat pump, which delivers the heat around the building.

Air source heat pumps act in a similar way to ground source pumps, but absorb heat from outside air. Check with the Council's Sustainability team for information on [government grants](#).

Both types of heat pumps need to consider other aspects as well, including design and amenity impacts.

To qualify under permitted development, heat pumps must also comply with Microgeneration Certification Scheme (MCS 020 standard)

Subject to limitations and conditions of General Permitted Development Order, Schedule 2, Part 14 - Renewable Energy, the following are permitted for single family dwellings and blocks of flats:

- Class A - Solar Panels**
- Class C - Ground source heat pumps**
- Class G - Air source heat pump**

COOLING AND AIR CONDITIONING UNITS



Air conditioning units are discouraged by the Council, in line with Policy CC2 and guidance in [CPG Energy Efficiency and adaptation](#).

If you are concerned that your home overheats in summer beyond comfort levels, you should consider passive cooling measures which do not rely on an energy source like air conditioning. The following measures could be taken to reduce overheating:

- Use shading (blinds, shutters, trees, vegetation), to be carefully designed to take into account the angle of the sun and the optimum daylight and solar gain;
- If you are planning an extension, use smaller windows on the south elevation and larger windows on the north (a balance is needed between solar gains (heat) and daylighting);
- Include high performance glazing e.g. triple glazed windows, specially treated or tinted glass;
- Incorporate green and brown roofs and green walls which help to regulate temperature as well as providing surface water run-off, biodiversity and air quality benefits;
- Porches, atriums, conservatories, lobbies and sheltered courtyards can be thermal buffers, they provide a transition between the cold outside and the warmth inside a building (or similarly the reverse in warmer months).

Air conditioning units require planning permission and the submission should include a Noise and Vibration assessment as well the table in [Appendix 1](#) completed stating all the other measures that have been taken to address overheating in your home.

GREENERY AND BIODIVERSITY

Well-designed, planned and managed urban green infrastructure can bring a wide range of benefits to individuals, local communities and places, and can underpin sustainable economic growth.

The key benefits of green infrastructure are:

- **Climate change mitigation and adaptation;**
- **Regulation of air pollution;**
- **Flood alleviation;**
- **Quality of place;**
- **Health and well-being;**
- **Recreation and leisure, tourism.**

The focus of this guidance is maximising the benefits which can be derived from roofs and walls of buildings and private garden space which make a significant contribution to the Borough's wider green infrastructure.

When you extend the footprint of your home, through an extension or outbuilding, this would reduce the size of the garden area. Even if currently paved, gardens have potential for planting and sustaining wildlife, which planning officers would consider in their assessment of an application.

To balance this loss you should consider incorporating elements of greenery and biodiversity within the design of your extension or structure, such as green roofs, bird and bat boxes, and bug hotels.

Vines can reduce the heat transmission through a sunlit wall by providing shade and cooling to the immediate environment by evaporation

GREEN ROOFS / WALLS



For existing flat roofs or new extensions, you should consider the introduction of a green roof.

The key benefits of green roofs:

- provide adequate insulation to your roof
- absorb water runoff
- support biodiversity
- reduce the carbon in the atmosphere by capturing it in the plant tissue and soil substrate
- reduce air and noise pollution
- reduce urban heat island effect through increase in evapotranspiration rate from the soil and plants
- reduce the proportion of infrared radiation returned to the air

The wellbeing of a green roof/wall depends on the type of plants used and can range from basic sedum roofs to intensively landscaped roofs. The choice of roof may depend on the building structure, location and design. You are advised to consider native plants first to enhance biodiversity.

Think long term:

The level to which you would enjoy the benefits listed above is dependent on the depth of your green roof substrate. A deeper substrate (more than 100mm) would allow for plants to establish themselves better with an increased longevity and would be acceptable by planning officers.

More information can be found in the [Energy Efficiency and Adaptation CPG](#).

Similar to green roofs, green walls have good insulation properties whilst improving the biodiversity, reducing the carbon around your property and enhancing amenity.

Complete the checklist of measures in [Appendix 1](#) and submit with your planning application to demonstrate what you have considered.

WILDLIFE



Wildlife in the UK is protected under the Wildlife and Countryside Act (1981) (as amended). Before you start any works to your property you need to make sure wildlife and protected species would not be affected. In Camden, species most likely to be affected by development are nesting birds, bats, hedgehogs and reptiles.

Any works that would affect **breeding birds** and their nests, such as works of demolition, vegetation removal or site clearance, should be done outside the nesting season from 1st of March to 31st July inclusive. To help wild birds you can install bird boxes within your garden or 'swift bricks' within external walls, in a shaded location. The Royal Society for the Protection of Birds can provide advice on how to retain or create nesting spaces within the eaves. Also note that any scaffolding even for minor external works can prevent birds accessing their nest sites in buildings.

Bats are in rapid decline in the UK. In urban environments, bats use existing holes and gaps in trees and buildings for nesting. They can fit in gaps as small as a human thumb, so be mindful of missing tiles or gaps within the roof soffits before you start any works. To help them you can make and install bat boxes within your garden or external walls of your home facing south. See more information about this at [Bat Conservation Trust](#). To find out if you are located in an area populated by bats see [The London Bat Group](#).

Hedgehogs are in significant decline. They generally live and nest under piles of leaves and twigs. Before you start any works of site clearance or vegetation removal, check for hedgehogs. You can adapt your garden to be hedgehog (and other wildlife) friendly by allowing gaps within your boundaries for them to move and find food and shelter in the neighbourhood. You can find out more about hedgehogs and how you can help them on [Hedgehog Street](#).

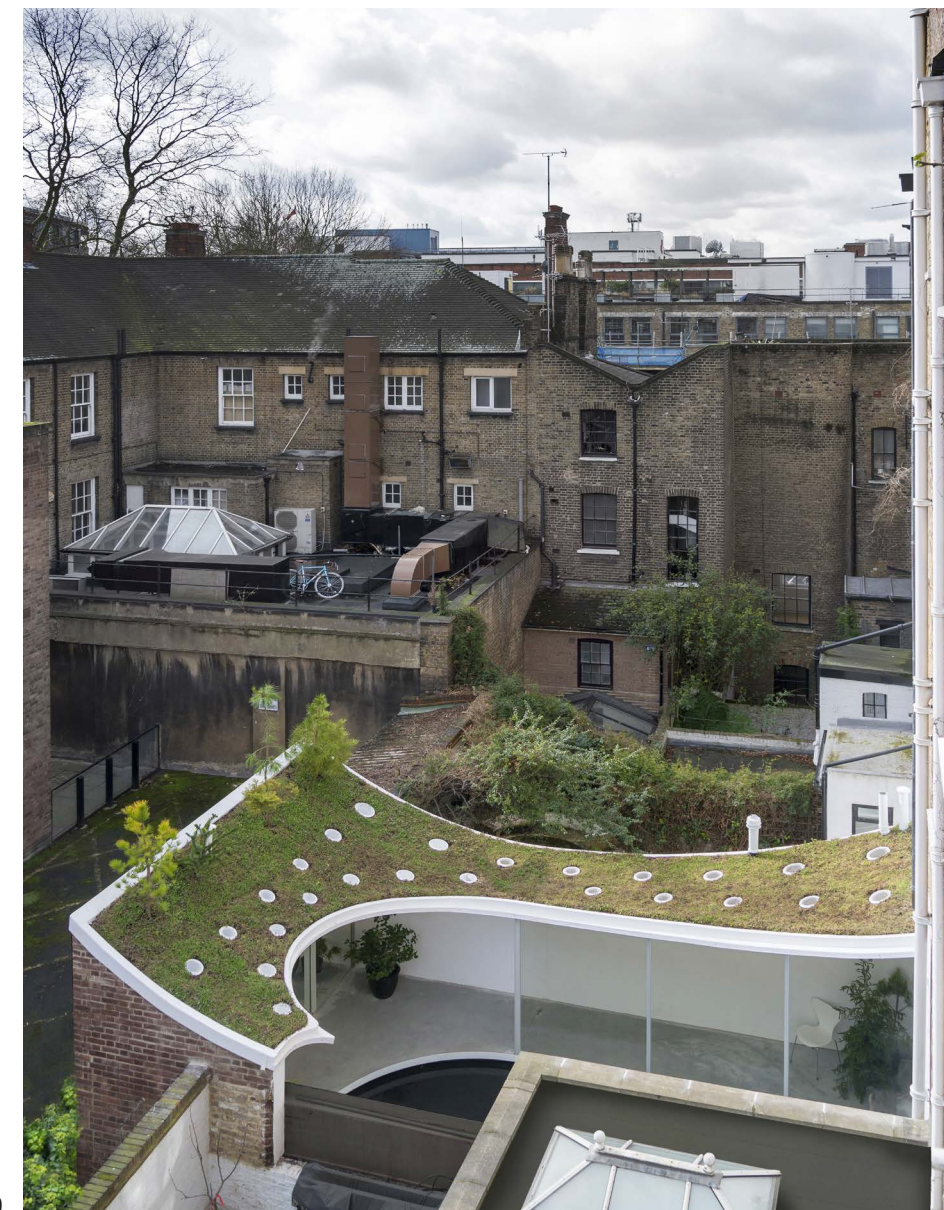

Photo 9



Photo 10



Photo 11



Photo 12

NEIGHBOURS



These standards are to ensure that the proposed changes to your home would take into consideration the neighbouring properties and ensure the amenity of your neighbours would not be harmfully affected.

When designing your home improvement you need to consider the impact that this will have on your adjoining neighbours in relation to the following key considerations:

- Daylight & Sunlight
- Outlook
- Overlooking/Privacy
- Noise

You should particularly take into consideration what room the potential impacted window/s serve. The impact on habitable rooms (bedrooms, living rooms, kitchens, diners) is of a greater concern than on non-habitable rooms (bathrooms, hallways, staircase landing, others).

We would strongly encourage you to speak to your neighbours about your proposed development, prior to submitting a formal application to the Council.

The Council consults local residents on most planning applications, therefore if you have previously discussed your proposal with your neighbours, and taken into account their views, they may be less likely to object.

If you and your neighbour decide that you would both like to build an extension which when assessed on their own merits might have an adverse impact, you could consider submitting a 'joint application'. A joint application will usually be subject to conditions or section 106 legal agreement to ensure that both extensions are constructed at the same time, to avoid adverse impact.

Regardless of the type of alteration or extension you are planning there are some

basic principles that you should consider:

- **Ensure your proposal does not reduce your neighbours access to daylight & sunlight;**
- **Design your home improvement to not infringe on your neighbours outlook from their windows and garden;**
- **Ensure any opportunities for overlooking into or from your neighbour's property are removed and privacy for all properties is maintained;**
- **Ensure your extension or alteration does not result in excessive light pollution that adversely impacts adjoining properties;**
- **If you're proposing plant equipment, ensure it is sensitively designed and acoustically enclosed so it does not become a nuisance for your neighbouring properties.**

For more info please see [CPG Amenity](#).

A joint application could remove the impact of the extension on each other if on the same side/position of the house

IMPACT ON NEIGHBOURING AMENITY

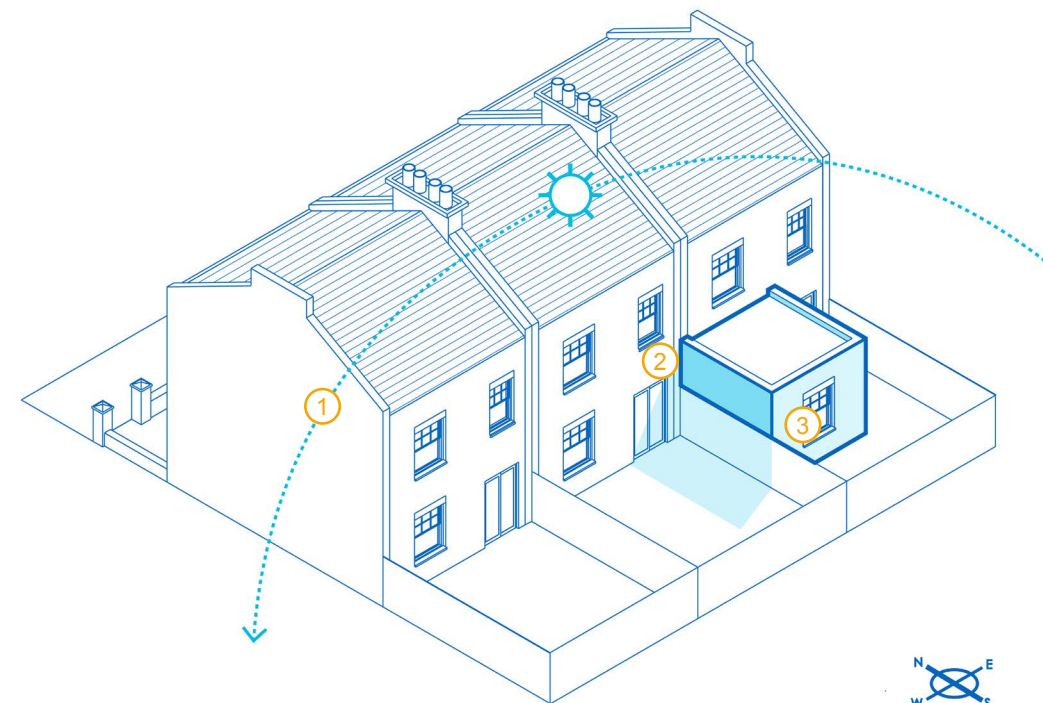

The new extension (in light blue) considered the position and location of neighbouring windows, and sun orientation. The extension would not cause harmful impact in relation to loss of light, outlook, and privacy to the neighbouring amenity.

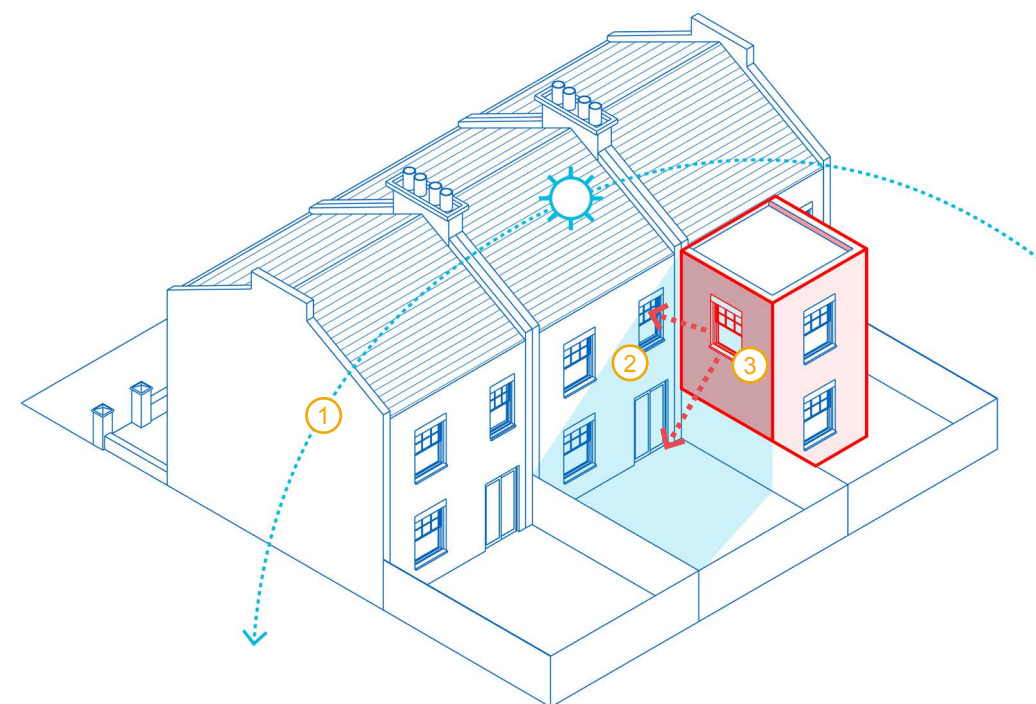

The new extension (in light red) did not take into account the position and location of neighbouring windows, sun orientation or the actual proximity to the neighbourin building. The extension would result in harmful reduction of daylight, sunlight and outlook to neighbouring windows and harmful overlooking.

COMMUNITY



These standards encourage you to appreciate your property belonging within a wider community and therefore seek to ensure that your proposal does not adversely impact the streetscene, local neighbourhood, and the wider built and natural environment surrounding your home.

Home improvements should respect and respond positively to the surrounding context, so that its character is maintained or enhanced. The quality of the streetscape derives from a multitude of factors, such as boundary treatments, front gardens, greenery, flank walls, pavement treatment, roofscape, rhythm of buildings and their features. Depending on the type of improvement you are looking to make to your property, you should be aware of how this would impact the streetscape and therefore the wider area you live in.

If you live in a Conservation Area, the elements of streetscape make a greater contribution to the character and appearance of the area. In this instance, your proposal should not cause harm to this established setting as described in [Conservation Area Appraisals](#), but rather to preserve or enhance the area.

Communities can influence the future of your neighbourhood by preparing a Neighbourhood Plan. This sets out the vision for your local area and gives general planning policies to guide developments. You can find out if your area already has a [Neighbourhood Plan](#) on the Council's website.

General points to be considered in the design process for your proposal:

- **Character and proportions of host building, neighbouring ones and wider area;**
- **The existing common pattern of development and rhythm of gaps, buildings and street features;**
- **The visibility of your property from long views along the street, from further away if it sits at higher level, and from public spaces;**
- **Respect existing natural environment;**
- **Incorporate high quality landscape design and maximise opportunities for greenery;**
- **Boundary treatments and their relation to the pavement and streetscene;**
- **Consider designing out crime measures to minimise crime and antisocial behaviour;**
- **Preserves strategic and local views.**

Communal Street facilities: bikehangars replace on street parking spaces with cycle storage for up to 6 bicycles. [Click here](#) for more information about this facility. Bikehangars do not replace an individual site's requirements for cycle parking when these apply.

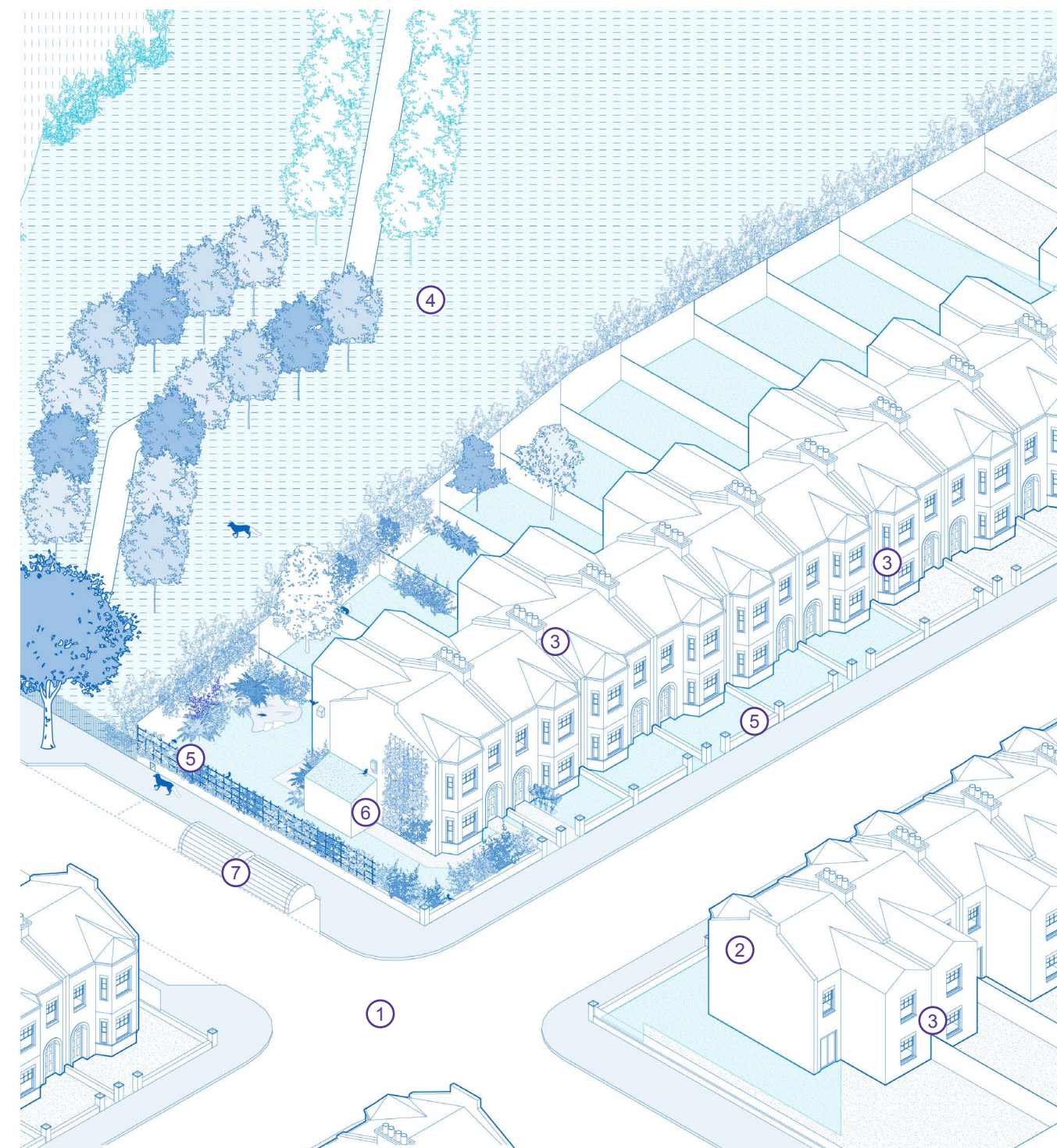

CONSIDERATIONS

1. Streetscene / views along the street
2. Prominent location
3. Rhythm and pattern of development

4. Open space
5. Gardens and boundary treatments
6. Street trees and greenery
7. Communal facilities / bikehangars

HOME IMPROVEMENTS

The changes you make to your home should always improve your living conditions. The following home improvements relate to the most common types of alterations and extensions and explain how the key principles apply within each. Make sure you consider all key principles when designing your scheme, as they are all material considerations in the officer's assessment of a planning application.

All homes, gardens and their context are different. Therefore, whilst your proposal would be expected to comply with the guidance, officers will apply this flexibility and every planning application will be assessed on its own merits.

1. MATERIALS

2. EXTENSIONS

2.1 Ground extensions

- Rear
- Side and front

2.2 Roof extensions

- Dormers
- New roof level
- Balconies

3. EXTERNAL ALTERATIONS

3.1 Windows and doors

3.2 Walls

3.3 External pipework

3.4 Roof

3.5 Rooflights

4. INTERNAL ALTERATIONS

4.1 Internal layouts

5. GARDENS

5.1 Landscaping

5.2 Front, rear and side gardens

5.3 Boundary treatments

5.4 Garden storage

5.5 Outbuildings

1. MATERIALS



Materials are integral to the architectural design, appearance and character of a building. The choice and use of materials and finishes therefore plays a crucial role in any alteration and extension given their impact on the appearance and character of a home (and Conservation Area if applicable).

The production of materials and construction processes are major consumers of resources and can produce a large proportion of waste and carbon emissions.

In all cases, the insulating quality of materials should be considered along with their embodied energy (the energy used in manufacture and transportation) and the potential for recycling in the future and re-use, especially relevant in the context of historic buildings.



Photo 13

In order to be acceptable by Officers, materials should be:

1.1 CONTEXTUAL

The texture, colour, pattern and finish of materials (detailing) should relate well to the existing character and appearance of both the existing home and the wider area, particularly in Conservation Areas and listed buildings.

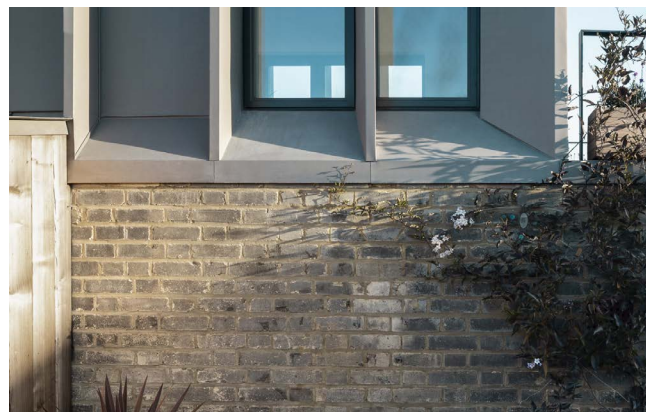

Photo 14

1.2 RESILIENT/DURABLE

Choosing a material that stands the test of time is crucial as there are many benefits to this. It would be affordable long term, it saves embodied carbon, and it would become part of the character of the property given its lifespan. The durability of a material should be appropriate for the expected lifetime of the building/element.



Photo 15



Photo 16

2.1 GROUND EXTENSIONS

There are several different types of extensions at ground level that you could consider to extend your home, depending on your housing type: terraced, semi-detached, detached.

As part of your preparation to extend your property at ground level, a preliminary site assessment is recommended, to consider the following:

- **The existing rear elevation and any previous extensions to it;**
- **The rear elevation's visibility and prominence in relation to gardens, streetscene and wider area;**
- **The pattern of development of neighbouring buildings to include historic extensions and new types of development;**
- **Other rear extensions present at the neighbouring buildings which obtained permission through a planning application or permitted development.**

This assessment could be done by walking along your street and surrounding area to observe the rear of properties. You could also use Google or Bing Maps images for an aerial or bird's eye view of your property and surroundings.

You can find out if a certain extension has a planning record by searching for planning applications on the Council's website.

For extensions to blocks of flats you should consider requesting pre-application advice prior to any formal submission.

Ground extensions could be single or multiple storeys in height, and could include but are not limited to: a rear extension to the main rear elevation, to the rear return, an infill rear extension, a wrap-around rear extension, infill side extension, corner facing side extension, front extension.

The type of extension that is appropriate for your property will depend on a number of factors

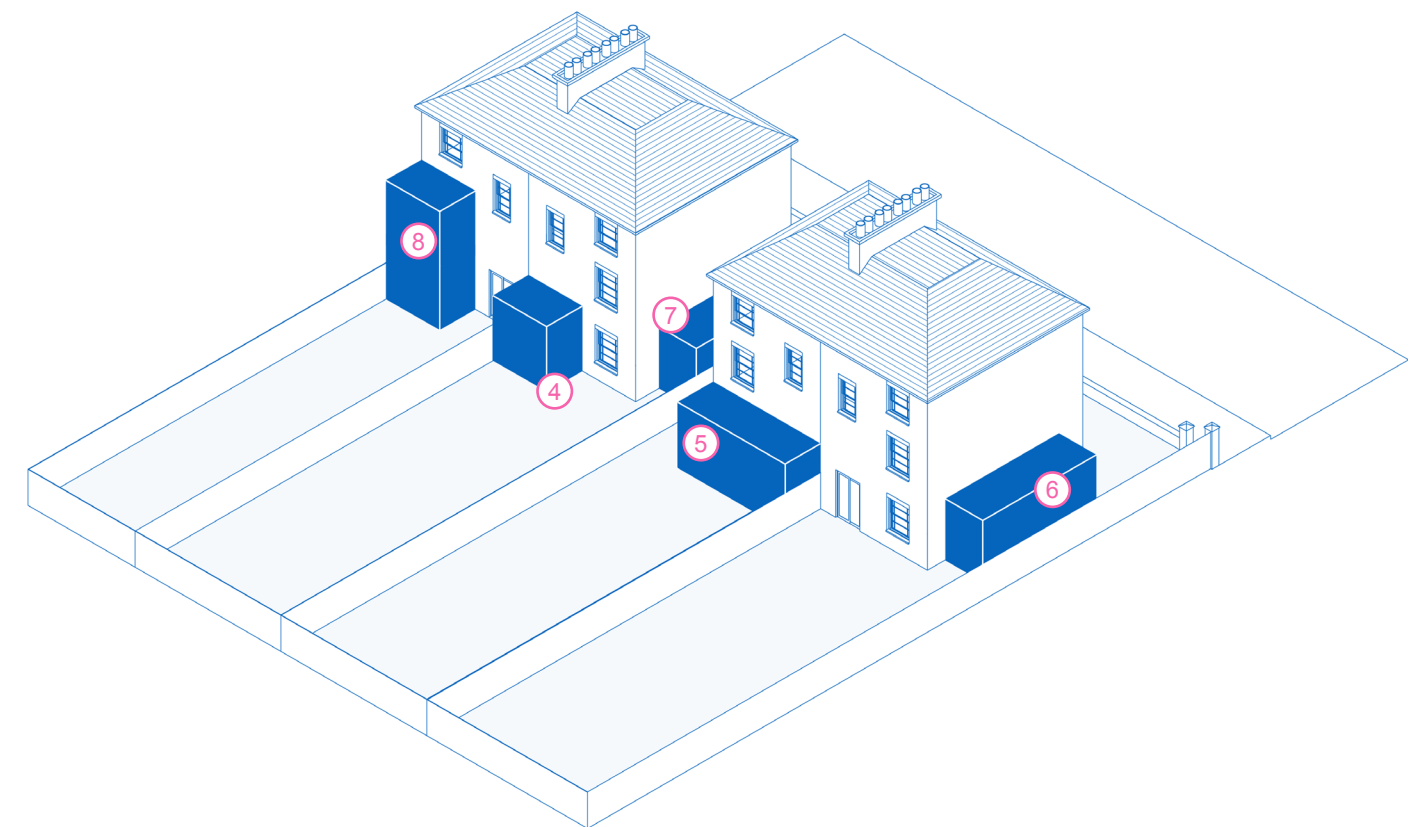
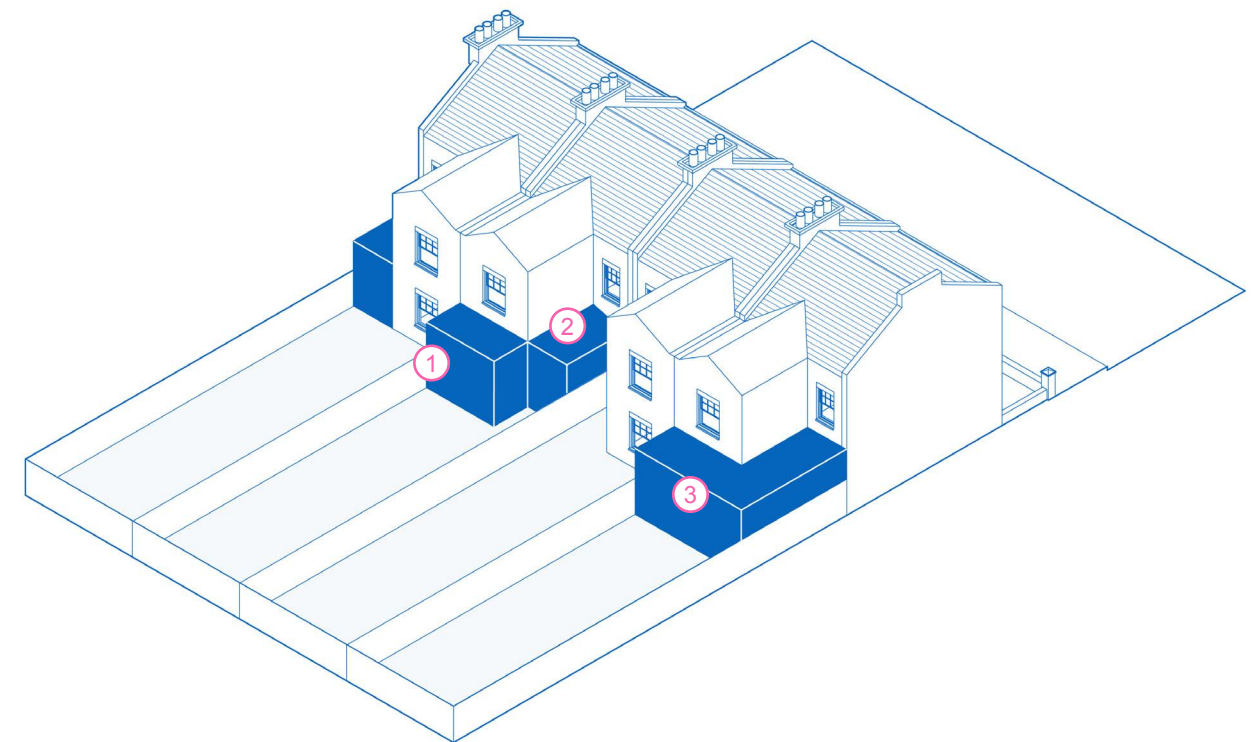

If your property is in a Conservation Area, check the Conservation Area Appraisal and the information about ground extensions.

A conservatory is also considered a form of extension, but with a glazed roof and glass as the predominant building material.

INDICATIVE EXAMPLES OF DIFFERENT TYPES OF REAR EXTENSIONS

1. Rear extension off the rear return
2. Infill rear extension
3. Wrap-around extension
4. Half width extension off main rear elevation
5. Full width extension off main rear elevation

TYPES OF SIDE EXTENSIONS

6. Side extension
7. Infill side extension
8. Two storey extension

The type of extension that is appropriate for your property will depend on a number of factors as set out in the following pages.

2.1.1 REAR EXTENSION

Depending on where your home is located, there are times when the rear of a building may be architecturally distinguished, either forming a harmonious composition, or visually contributing to the townscape. Where architectural merit exists, the Council will seek to preserve it when it is considered appropriate. Some of the Borough's important rear elevations are identified in Conservation Area Appraisals.

In some cases, a more innovative design approach could address specific site constraints and in others, a structure that matches the existing home may better respond to the existing context. It is recommended that pre-application advice is sought where it is unclear what design approach would suit the host building.

There are certain considerations that should be taken into account when designing a rear extension to ensure it is sensitively and appropriately designed for its context. **Rear extensions should:**

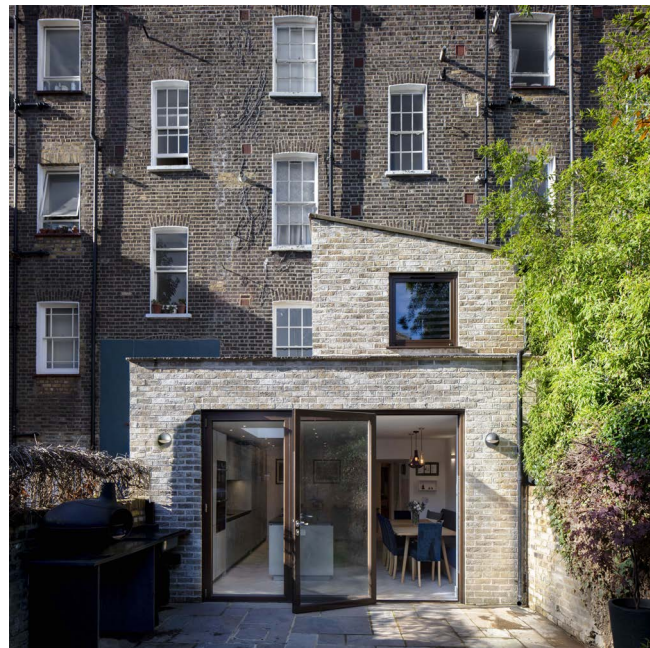

Photo 17



- Be subordinate to the building being extended, in relation to its location, form, footprint, scale, proportions, dimensions and detailing;
- Be built from materials that are sympathetic to the existing building wherever possible;
- Respect and preserve the original design and proportions of the building, including its architectural period and style;
- Respect and preserve existing architectural features, such as projecting bays, decorative balconies, cornices and chimney stacks;
- Be carefully scaled in terms of its height, width and depth;
- Allow for the retention of a reasonably sized garden;



- Ensure your extension complies with Building Regulations for energy efficiency measures which include insulating cavities and floors, making provision for low energy lighting, installing thermostatic valves on any new radiators;
- Consider the installation of green roofs/walls and/or solar panels. Biodiverse green roofs with a substrate depth of 100mm are preferred rather than sedum roofs, as they provide a greater biodiversity value. For further information about the installation of a green roof, see [CPG on Energy efficiency and Adaptation](#).
- Allow retention of wildlife corridors, in particular at the end of streets. For further information regarding protection measures of wildlife corridors, see [Biodiversity CPG](#).

The soil in green roofs/walls act as a natural insulator which is superior in terms of efficiency than most typical synthetic roof coverings and insulation materials.



- Respect and duly consider the amenity of adjacent occupiers with regard to daylight, sunlight, outlook, light pollution/spillage, and privacy;
- Ensure the extension complies with the 45 degree test and 25 degree test as set out in the [Amenity CPG](#) – or demonstrate BRE compliance via a daylight test;
- Consider if the extension projection would not cause sense of enclosure to the adjacent occupiers;
- Ensure the extension does not cause undue overlooking to neighbouring properties and cause a loss of privacy. Consider opaque lightweight materials such as obscured glass on elevations abutting neighbouring properties, in order to minimise overlooking;
- Not cause light pollution or excessive light spillage that would affect:
 - neighbouring occupiers, including to those above where a property is divided into flats;
 - Wildlife on neighbouring sites, particularly near sites identified for their nature conservation importance. Consider the use of solid lightweight materials such as timber, one-way glass or obscured glass, in order to minimise light pollution;



Photo 18



- Respect and preserve the historic pattern and established townscape of the surrounding area, including the ratio of built to unbuilt space;
- Retain the open character of existing natural landscaping and garden amenity, including that of neighbouring properties, proportionate to that of the surrounding area;
- Have a height, depth and width that respects the existing common pattern and rhythm of rear extensions at neighbouring sites, where they exist.

If you live in a Conservation Area, you should check the Conservation Area Appraisal and be aware of what contributes to its significance. It might be that the rhythm of the original rear return is significant, and therefore the proposed design of extensions should respect this feature.



Photo 19

2.1.2 SIDE & FRONT EXTENSIONS

When designing a side extension be aware that given its likely visible location in relation to the streetscene, it could have a greater impact on the host building, group of buildings and wider area. Gaps between buildings could help to soften the urban grain and provide visual interest and it is important you consider existing trees and vegetation within the design of the proposed extension.

In some cases, a more innovative design approach could address specific site constraints and in others, a structure that matches the existing home may better respond to the existing context. It is recommended that pre-application advice is sought where it is unclear what design approach would suit the host building.

Front extensions including porches are usually highly visible alterations that can change the character of a building and the street. They can have a particular impact where front gardens are an important characteristic of the area, and where the street has a regular pattern of buildings and a clearly defined building line (as in many streets of terraced and semi-detached houses). You should always consider pre-application advice prior to submitting a proposal for a porch.

New development along the side of the building should ensure it unlocks potential development to the neighbouring properties.

There are certain considerations that should be taken into account when designing a side extension to ensure it is sensitively and appropriately designed for its context. **Side extensions** should:



- Be set back from the main front elevation;
- Be secondary to the building being extended, in relation to its location, form, footprint, scale, proportions, dimensions and detailing;
- Be built from materials that are sympathetic to the existing building wherever possible;
- Respect the dimensions of the existing front porch, where applicable;
- Respect and celebrate existing architectural features into new design, where they make a positive contribution to the character of the building or groups of buildings, such as projecting bays and porches.



- Consider adequate internal insulating materials;
- Consider the installation of green roofs/walls and/or solar panels. Biodiverse green roofs with a substrate of at least 100mm, are preferred rather than sedum roofs, as they provide a greater biodiversity value. For further information about the installation of a green roof, see [CPG on Energy efficiency and Adaptation](#).
- Allow retention of wildlife corridors, in particular at the end of streets. For further information regarding protection measures of wildlife corridors, see [Biodiversity CPG](#).
- An enclosed space internally or externally around an external door, will help with draught proofing and energy saving.



- Respect and duly consider the amenity of adjacent properties with regard to daylight, sunlight, outlook, light pollution/spillage, and privacy;
- Be designed to not cause overbearing or overshadowing to neighbour's front gardens and the interior of their home.
- Be designed to not result in sense of enclosure to the adjacent occupiers;
- Respect and not overlook neighbouring properties and cause loss of privacy. In order to minimise overlooking, opaque lightweight materials such as obscured glass may be necessary on elevations abutting neighbouring properties.



- Protect significant views or gaps;
- Ensure the established front building line is not compromised;
- Ensure the architectural symmetry or integrity of a composition is unimpaired;
- Ensure the original architectural features on a side wall are not obscured;
- Retain access to the rear of a property;
- Consider a sensitive approach for corner extensions which takes into account the neighbouring context.



Side extensions should be confined to a single storey, but there may be instances where a taller side extension could be permitted.



Photo 20

If you live in a Conservation Area, it is particularly important you check the Conservation Area Appraisal for your area and be aware of what contributes to its significance to inform your proposal. It might be that the gaps between buildings are significant, and therefore the proposed design of extensions should take this into account.

Properties in Conservation Areas DO NOT have permitted development rights for side extensions, nor for two storey extensions.

2.2 ROOF EXTENSIONS

Extending the roof to make it a habitable space is one of the most common and affordable types of development. There are times when only a small alteration, such as the installation of a dormer window could make your loft space habitable by providing more space and headroom.

As part of your preparation to alter or extend the roof of your property, a preliminary site assessment is recommended, to consider the following:

- **The existing roof form and any previous extensions to it;**
- **The roof visibility and prominence in relation to gardens, streetscene and wider area, considering land topography;**
- **The pattern of development of neighbouring buildings to include historic extensions and new types of development;**
- **Other roof extensions present at the neighbouring buildings which obtained permission through planning application or permitted development.**

This assessment could be done by walking along your street and surrounding area to observe the roof forms. You could also use Google or Bing Maps images for an aerial or bird's eye view of your property and surroundings.

You can find out if a certain extension has a planning record by [searching for planning applications on the Council's website.](#)



Photo 21

A successful roof extension would consider the overall roof form of the existing building, adjoining buildings and impact in key views (when relevant) and be proportionate to the roof slope being extended.

The previous guidance presented a hard line approach of restricting development at roof level on any unbroken roofline. Under this guidance, a more flexible approach is proposed, to give more weight to existing older extensions and to those allowed under permitted development, in the immediate context of the building being proposed for extension, within and outside Conservation Areas.

Not every unbroken roofline is of heritage value and therefore it is not worthy of preservation.

For buildings in Conservation Areas, the Conservation Area Appraisals identify if certain terraces or groups of buildings are significant due to their unbroken roofline, which means they hold heritage value. If subsequent development since the Conservation Area Appraisal has been issued, has altered the unbroken roofline, weight shall be given to the existing extensions, in the assessment of a new roof extension.

If your property is in a Conservation Area, check the Conservation Area Appraisal and the information about roof extensions.

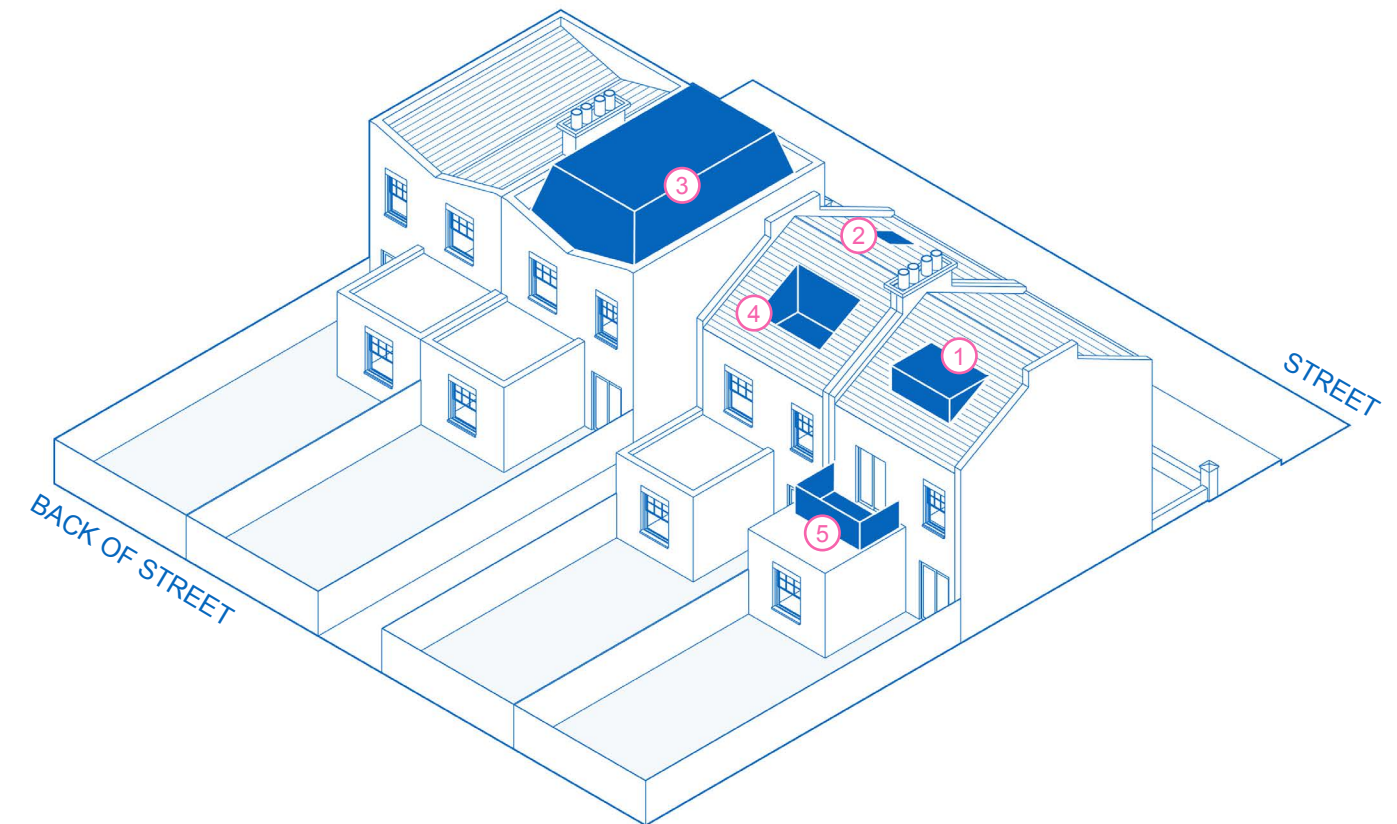

INDICATIVE EXAMPLES OF DIFFERENT TYPES OF ROOF EXTENSIONS

1. Dormer
2. Rooflight
3. Mansard
4. Inset balcony
5. Balcony



Photo 22

2.2.1 DORMERS

Dormers are defined as a window that projects out of a sloping roof. The aim of the dormer structure is to house a vertical window to bring in more light and air into the loft space and make it habitable, without adding to the overall roof height.

The design of a dormer should therefore emphasise the glazing element and the solid structure should complement this in a form and scale appropriate to the roof being extended.

Roof dormers should sit within the roof slope and appear as an extension to the existing roof whilst the existing roof form is maintained.

Dormer windows fall within permitted development rights of single family dwelling houses (not flats) outside Conservation Areas subject to limitations and conditions set out under Town and Country Planning (General Permitted Development) (England) Order 2016 (as amended) Schedule 2, Part 2, Class B.

[Check the order and Householder Technical Guidance by Gov.](#)

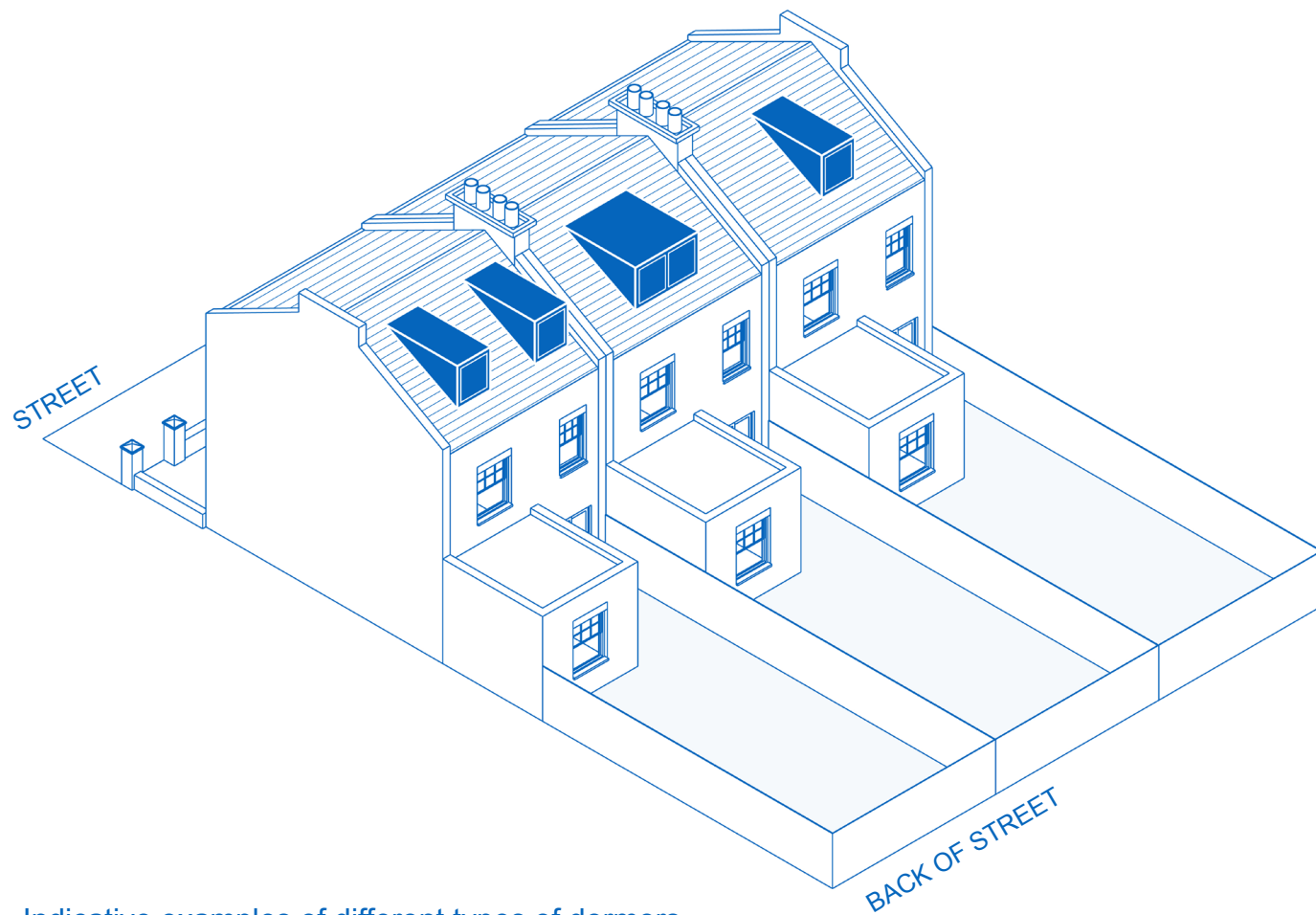

Indicative examples of different types of dormers for properties in Conservation Areas.



Photo 23



Photo 24



Photo 25



Photo 26

There are certain considerations that should be taken into account when designing a dormer window to ensure it is sensitively and appropriately designed for its context. A **dormer window** should ensure:



- The internal height of the existing loft space is sufficient to allow adequate habitable space more than 2m - headroom from staircase;
- Dormers should be subordinate in size to the roof slope being extended;
- The position of the dormer would maintain even distances to the roof margins (ridge, eaves, side parapet walls);
- Design of dormers would consider the hierarchy of window openings in terms of size and proportion, which generally result in smaller dormer windows than the ones at lower levels;
- The type, design and alignment of windows would relate to the ones below;
- The proportion of glazing should be greater than the solid areas and dormer cheeks should be of a high quality design and materials;
- Innovative approaches are encouraged and supported by pre-application advice;
- Dormer materials should complement the main building and wider townscape. Given the existing building stock, the use of traditional materials (timber, lead, hanging tiles) is encouraged; innovative approaches are encouraged and supported by pre-application advice;



- If not done already, consider insulating your whole roof;
- Include insulation materials into the dormer design and proposed drawings submitted;



- Consider whether the roof of your property is part of an unbroken roof line which is of heritage value - as set out in the Conservation Area Appraisal for your area;
- Consider whether there are other existing extensions in proximity, even if they are older or constructed under permitted development;
- Consider whether the dormer would have been permitted development if the property had not been converted into flats, only for properties outside Conservation Areas;
- On front roofslopes dormers could be a harmful addition due to its visual impact on the streetscene, especially in an unbroken roofscape. If your neighbouring properties do not have front dormers, then it is likely that this type of development would not be supported at application stage. Consider rear dormers and front rooflights instead;
- For side dormers you should balance carefully the dormer's quality and detailed design with its impact on streetscene and wider area. Side dormers in between buildings should carefully consider the existing architectural features on side elevation, such as chimney breasts and pots, and impact on the neighbouring amenity in terms of overlooking;
- Generally roofs of properties in Conservation Areas are part of the area's character, and as a general rule, dormer windows should retain a greater area of roof slope than properties outside Conservation Areas in order to preserve this character.

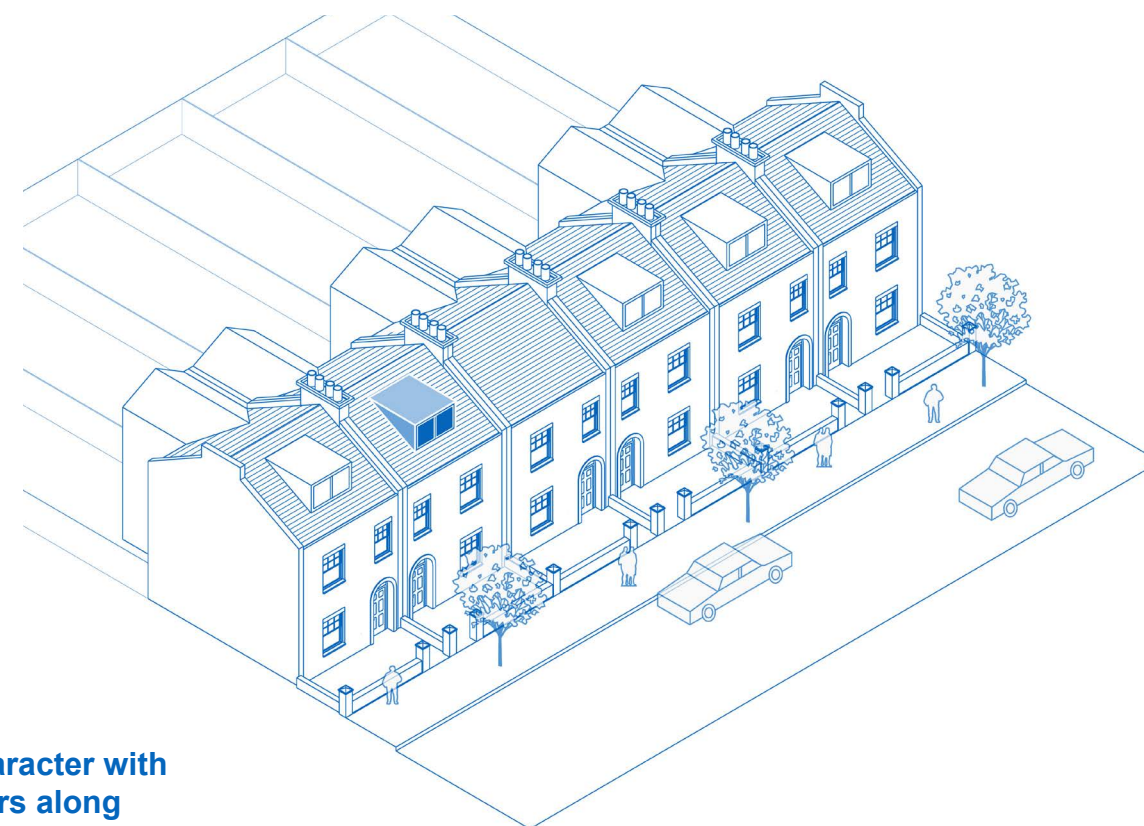

Existing character with front dormers along the street. Likely that a similar extension would be acceptable under a planning application.



On an unbroken roofslope, front dormers are unlikely to be supported by officers. You should consider rear dormer and front rooflight instead.

2.2.2 NEW ROOF LEVEL

Extending properties with a new storey at roof level is a well established method to increase the useable space of properties. This type of extension would retain more space at ground level available for greenery, garden storage and outdoor activities.

The most common type of extensions to the roof are mansards, traditionally associated with Georgian or Victorian buildings, as the existing roof structure with front parapets or valley roofs allow for a simple insertion of a new level in this traditional form.

In general, a traditional approach for mansard extensions would be preferred for traditional buildings. You are also encouraged to think about different approaches to additional roof levels. It is recommended that pre-application advice is sought where it is unclear what design approach would suit the host building.

There are two types of mansard roof extensions: a true mansard (A) and a flat topped mansard (B). In order to be designed successfully, you should follow the details below:

- The lower slope (usually 60-70°) should rise from behind the parapet wall, separated from the wall by a substantial set back and gutter;
- Retention of roof features such as original cornice, parapet, and chimney stacks;
- Windows should respond to the fenestration character of the host building and generally project at right angle similar to a dormer window with timber sash openings; and
- Materials to complement the existing roof and building and respond to the neighbouring context.

If you live in a terraced building and your neighbours have already extended their roofs with a traditional mansard, then it is likely that a similar extension would be an acceptable development.

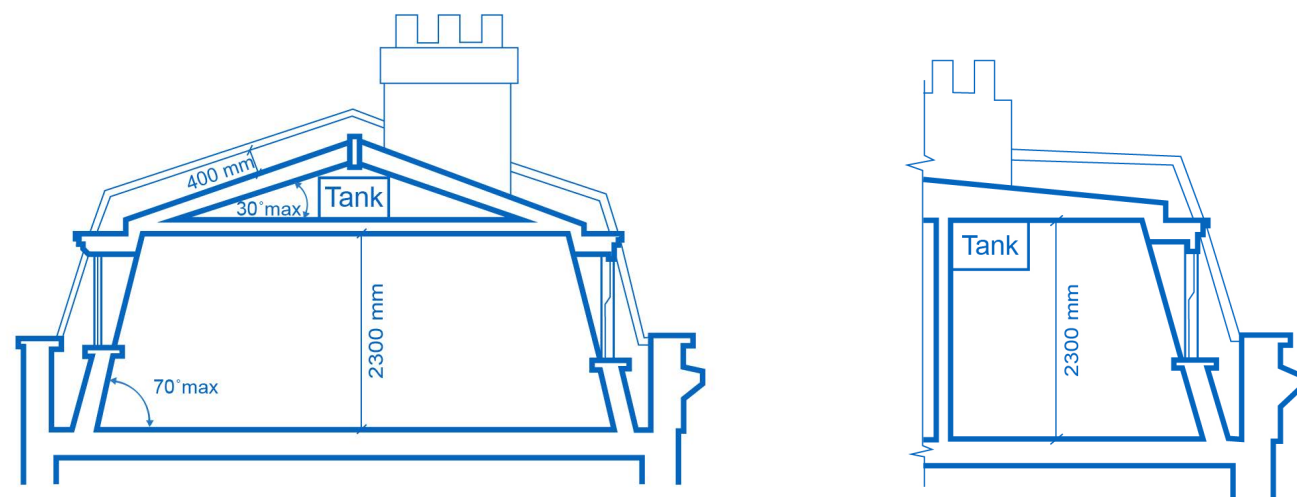

Mansard roof extensions: A. True mansard (left); B. Flat topped mansard



Photo 27

Above - Bad example of mansard extension which did not take into account the existing V shape roof parapet.

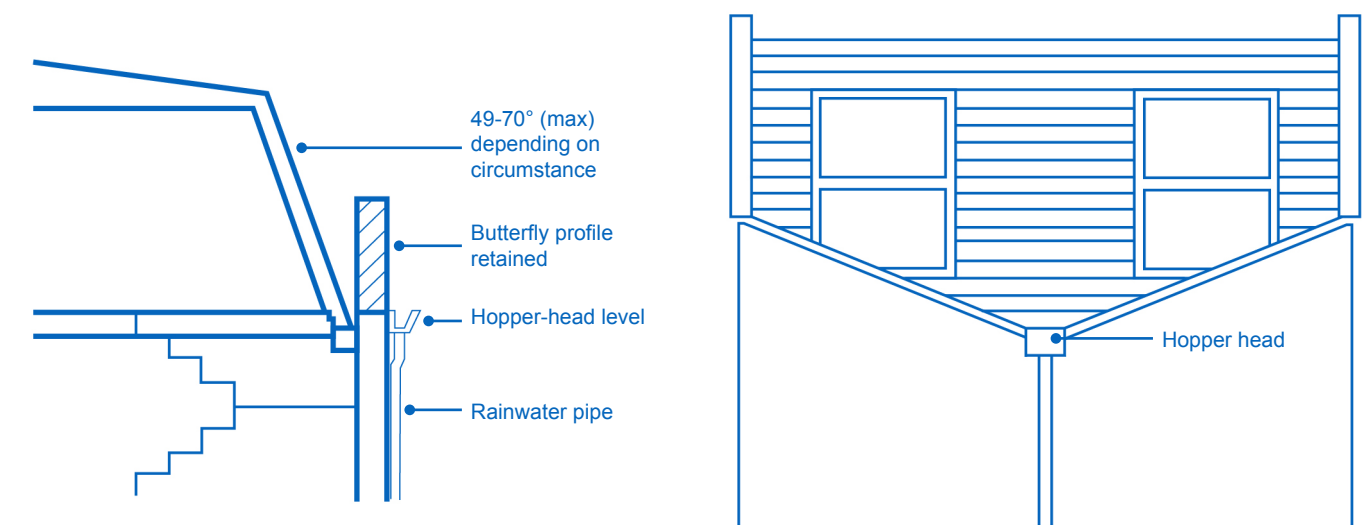

Example of mansard on butterfly roof

There are certain considerations that should be taken into account when designing an additional roof level, to ensure it is sensitively and appropriately designed for its context.

A new roof level should:



- Be subordinate to the host building;
- Include features informed by the host building and surrounding context;
- Take the form of a traditional mansard, a modern interpretation or a more innovative approach, supported by pre-application advice;



- Consider the installation of green roofs and/or solar panels. Biodiverse green roofs with a minimum substrate of 100mm are preferred rather than sedum roofs, as they provide a greater biodiversity value. For further information about the installation of a green roof, see [CPG on Energy efficiency and Adaptation](#);
- Consider other greening opportunities through planters;
- Consider adequate insulation materials to the new roof and floor below;
- Consider shutters and thick curtains to aid with the overheating in summer;

You should discuss your proposal with your neighbours to explore the possibility of a joint application. This could be secured by a section 106 legal agreement to ensure works are undertaken simultaneously.



- Be aware of the prominence of your home's roof to appreciate what impact an additional roof level would have on the streetscene and wider area;
- There are cases when an additional roof level could help re-unite a group of buildings and wider townscape. You should consider the scale of the adjacent development if proportionate to the host building and streetscene and reflect this into your proposal;
- Erecting a roof extension on a building within a complete terrace or group that currently has no extensions and it is not identified in Conservation Area Appraisals as being significant for its roofline, it is likely to be acceptable, generally, in a traditional form. If the complete terrace or group is identified as significant for its roofline, a new roof level is likely to not be acceptable regardless of its form. It is strongly recommended that pre-application advice is sought where it is unclear what design approach would suit the host building. You should also discuss your proposal with your neighbours to explore the possibility of a joint application;
- Where a group of buildings are originally designed as a complete composition a comprehensive design for the whole group is encouraged. Your design should be supported by pre-application advice, prior to a planning application submission. If a comprehensive design for the whole group is not achievable, you should still consider pre-application advice to ensure your proposal would not block further development;
- If buildings are part of a group where differing heights add visual interest, you should consider maintaining that pattern into the design of the new roof storey.



Photo 28



Photo 29

2.2.3 BALCONIES AND TERRACES

Balconies can provide valuable amenity space, especially for flats that would otherwise have little or no private exterior space. When considering a balcony for your property, it is important you appreciate the impact of this alteration on the roof form, host building, wider area and neighbouring amenity.

Depending on their size, balconies could generate harmful noise disturbance to your neighbours when in use. The intensity of the use of a balcony depends on the size and number of people they could accommodate at one time. A modest balcony is more likely to receive consent than larger ones.



Photo 30

There are certain considerations that should be taken into account when designing a **balcony**, to ensure it is sensitively and appropriately designed for its context. A new balcony should:



- Be subordinate to the roof slope being altered, and roof form overall;
- Preserve the roof form and complement the elevation upon which they are to be located;
- In case of pitched roofs, be set in within the roof slope, when possible;
- Should maintain the existing parapet height;
- Handrails and balustrades should be set back behind the line of the roof slope or parapet;
- Carefully consider materials for enclosure:
 - For traditional buildings, metal railings are preferred as they integrate well with the building's character, are more resilient, require low maintenance, support plants growth;
 - Glass balustrades could be appropriate for modern buildings with thin frames, or frameless; note they can generate sun reflection, are difficult to maintain clean, and do not support plants growth.
 - Timber balustrades could be appropriate at lower levels;
 - Raised parapets could contribute to shading where necessary and have different patterns, such as hit and miss brick pattern.
- The design of the balcony should take into account the risk of creating climbing opportunities for burglars;



- Consider spaces for planters within your balcony for screening and enhancement;
- When deemed necessary, privacy screens should be made of natural materials and allow plants to grow on them; plants act like a sound barrier, provide shade and lower air temperature;

You should engage with your neighbours prior to submitting an application for a balcony, so you can appreciate the impact this would have on their amenity.

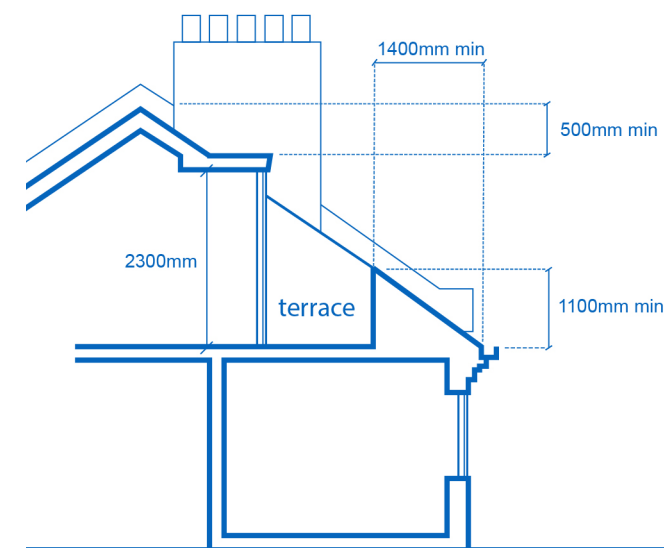

Modest balcony, set in within the roof slope provides amenity space and retains the roof form.



- Be located at the rear of properties to ensure no impact on the streetscene and wider area;
- Be set back from roof's margins;
- For balconies as part of a roof extension within a valley roof, the front and rear parapet of buildings should be retained and balustrades to sit behind them;
- When deemed necessary, privacy screens should be no less than 1.8m in height, made of natural materials and support plants to grow on them.

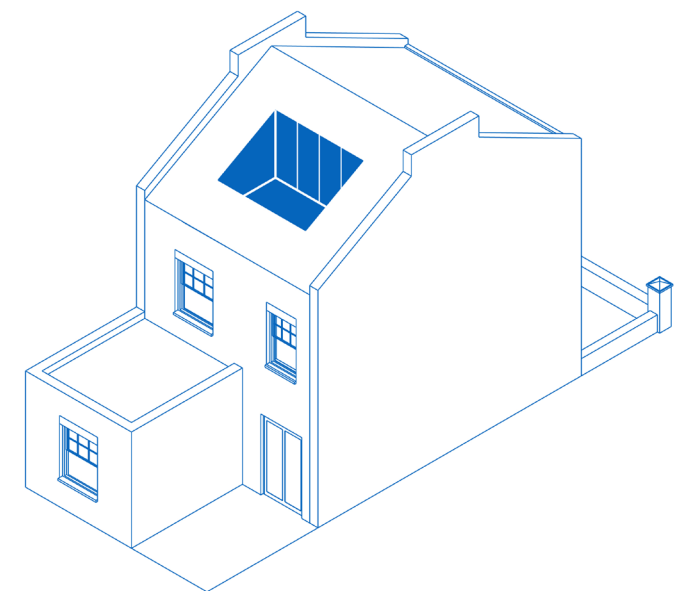

3. EXTERNAL ALTERATIONS

3.1 WINDOWS AND DOORS

REPLACEMENT

A like-for-like replacement means that certain elements of the window or door are to be retained as indicated below, except for the glazing which could be changed from single to double glazing:

- **Shape and dimensions of window opening;**
- **Frame material and dimensions to include frame profile width and depth;**
- **Fenestration pattern, to include the layout/pattern of glazing bars;**
- **Size and placement of structural glazing bars;**
- **Opening method, such as sliding sash, outward or inward opening casement window, tilt-and-turn etc.**

If your property is in a Conservation Area you are encouraged to consider Historic Glass.

The Council also encourages the restoration of original features if appropriate.

Please note that uPVC windows are strongly discouraged for both aesthetic and environmental reasons.

Timber window frames have a lower embodied carbon content than uPVC and aluminum – this is the carbon dioxide emissions from the extraction, refinement, transport and process.

Examples of like-for-like replacement of single glazed timber sash window with double glazed:

Above: good example showing the only difference being the double glazing element retaining the structural glazing bars and thickness of frames.

Below: bad example showing stuck on glazing bars, which easily deteriorate.

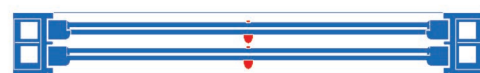
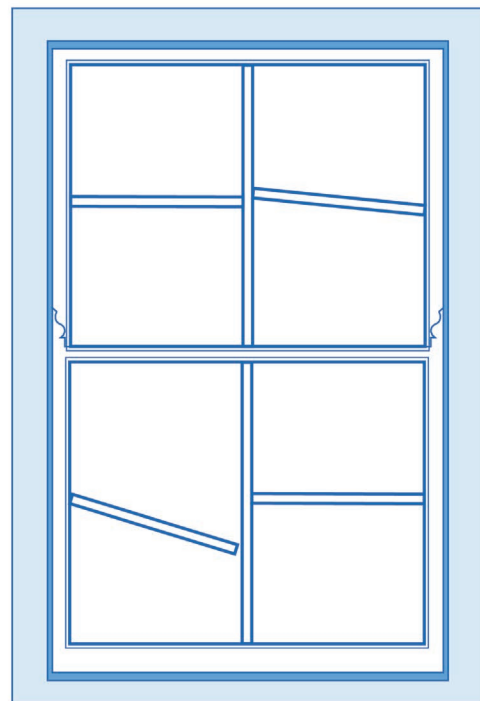
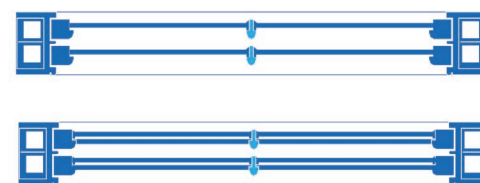
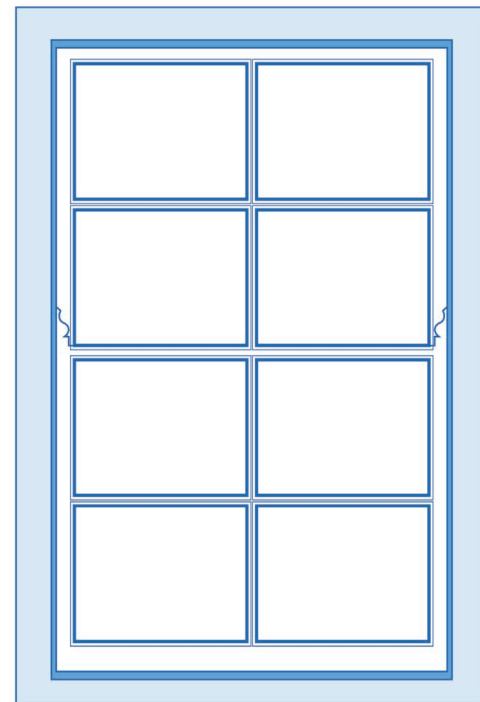

A like-for-like replacement of an existing window is not considered development, therefore does not require planning permission.

NEW

New windows and doors should generally be designed and composed of materials and finishes sympathetic to the original window and/or doors to the building. There are cases where materials and designs which are contrasting contemporary additions would be supported.

Replacing the windows on a historic building is not the most cost effective and energy efficient alteration you could make. First things you should consider are draught proofing, general overhaul of opening mechanisms, use of heavy curtains and shutters and secondary glazing installed internally.

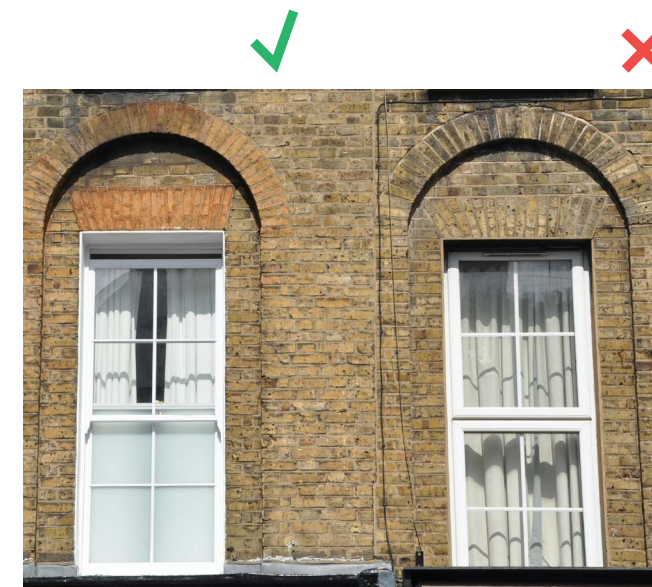
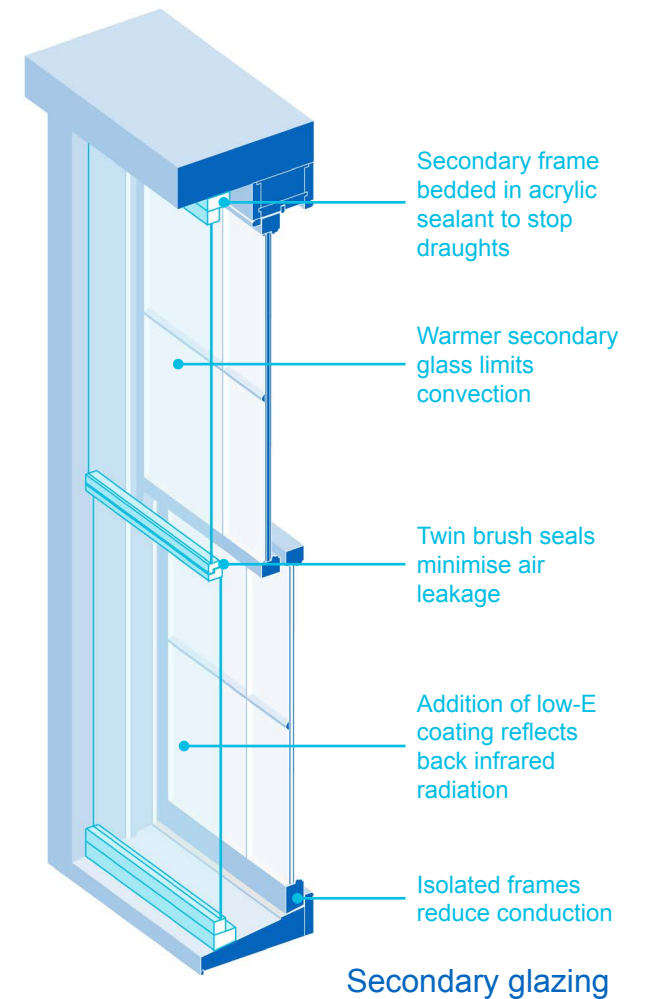

Photo 31



Photo 32



Photo 33

3.2 WALLS

Surface finishes, both inside and outside your home and local area, should respect and be sensitive to the physical and natural features, to include the building's detailing as well as topography and planting.

BRICKWORK AND STONEMWORK

Where possible you are encouraged to:

- Repair brickwork and stonework, in materials and techniques sympathetic to the site context, whether using new or matching materials.
- Consider the choice of mortar colour, grain and texture, bonding and pointing profile, while also satisfying the need for durable and sustainable materials, and the requirements for future maintenance.
- Use lime based materials as they are sustainable and natural, help the building resist against moulds, absorb carbon and require less energy to produce than cement, relatively easy to remove from bricks which increases the possibility of re-using the bricks.



Photo 34

PAINTING, RENDERING OR CLADDING OF BRICKWORK

The original exterior wall finish of a building is an important aspect of its architecture and should be preserved, whilst the following should be considered:

- Consistency of original elevation finishes can contribute positively to the character and appearance of a group of buildings and wider areas.
- As a general rule, where original masonry or in modern buildings, concrete or cladding is exposed on exterior walls, it should not be painted, rendered or over-clad. If in doubt, request pre-application advice.
- For exterior bricks and stucco finishes traditionally painted, care should be taken to use sympathetic non-synthetic paints, and to replicate the original colour and texture or that of matching neighbours.
- The colour schemes of neighbouring buildings, and any available documentation or guidance including Conservation Area Appraisals, covenants from certain landowners/freeholders.



Photo 35

3.3 EXTERNAL PIPEWORK

Original external pipework and guttering should be repaired or reinstated in a like-for-like manner for all properties, and the following considered:

- Any new pipework should be restricted to the side and rear elevations of buildings where possible in order to avoid harming the appearance of the principal elevation. These should be grouped together and located in a discreet position;
- Regular maintenance of external gutters and downpipes is important to avoid water ingress into the building either through the roof or the walls.

Properties in Conservation Area DO NOT have permitted development rights for cladding any part of the house with stone, artificial stone, pebbledash, render, timber plastic or tiles.



Photo 36

For properties in Conservation Areas, new external pipework on a wall or roof slope which fronts a highway and forms either the principal elevation or a side elevation of the dwellinghouse would require planning permission.

Painting or rendering masonry can also cause physical damage to buildings through inhibiting the breathability of traditional natural materials or trapping moisture in walls. For these reasons synthetic emulsion paints and cement-based renders are generally inappropriate.



Photo 37

3.4 ROOF

In terms of the external appearance of the roof, ongoing maintenance and repair or partial replacement of roof coverings, on a like-for-like basis where original materials survive, is preferable to wholesale replacement, because:

- **It is cost effective;**
- **Sustainable; and**
- **Would maintain consistency of finish and weathering for groups of buildings.**

As a general rule, for both roof alterations and repairs, materials that visually blend with or match the existing building materials should be considered, including clay tiles, natural slate, lead or copper.

Where roofs are being refurbished, original keyhole ridge tiles or decorative chimney stacks and chimney pots should be reused, and where possible, re-instated if they have been removed. Attention should be paid to matching any traditional overlap pattern, especially when using natural slate (and some tile types).

Insulating the roof is one of the most energy and cost effective ways of upgrading your property's thermal performance. See Sustainability chapter for more details on roof insulation.

Internal roof insulation without changing any external dimensions of the roof does not require planning permission.



Photo 38

3.5 ROOFLIGHTS

The installation of a rooflight can help to make the space in your loft habitable, by providing light and ventilation whilst maintaining the angle of the roof slope.

Before considering altering the roof of your property with rooflights, it is important you appreciate how these would change the materiality and solidity of your roof, and therefore its appearance and character as seen from the surrounding area including in views from public spaces.

Prominent and steep front roof slopes could be visible from long views along the streets and public spaces. In this instance you should consider locating rooflights on the rear slopes. Shallow sloping roofs may be less dominant and therefore could better accommodate rooflights even to front elevations.

If your property is part of a Conservation Area with Article 4 which removed PD rights for rooflights, this alteration would then require planning permission.



Photo 39

The following points should be considered when designing **rooflights** into the roof of your property:

- They should not protrude more than 0.15m beyond the plane of the roof slope or be flush with the roof slope for properties in Conservation Area;
- They are significantly subordinate both in size and number to the roof slope being altered and roof form overall;
- Their position should take into account other architectural roof elements, e.g. gables, chimneys, turrets;
- Their position and dimensions should ensure a consistent rhythm with other rooflights on adjacent/neighbouring roofs.
- For rooflights on the roof of ground floor extensions, they should be positioned away from the building line or obscured glazed - to not cause excessive light spillage. Especially relevant for buildings divided into flats.

Rooflights fall within permitted development rights of single family dwelling houses (not flats) subject to limitations and conditions set out under Town and Country Planning (General Permitted Development) (England) Order 2016 (as amended) Schedule 2, Part 2, Class C.

[Check the order and Householder Technical Guidance by Gov.](#)

4. INTERNAL ALTERATIONS



Internal alterations do not require planning permission from the Council, but they could improve your living conditions with less disruption and cheaply.

Whilst the Council would not discourage you from extending your home and creating more space, this can be expensive and disruptive so you might find other ways to make better use of the existing space.

Before planning an extension, you have the flexibility to adapt your home internally to make more space for relaxation, play, working from home, exercise or even for a new member of the family or an elderly relative.

Understanding the existing internal layout of your home is an important step in ensuring you can consider its full potential for adaptation.

Some of the benefits of adapting the internal layout of your home:

- **Generally the works are much cheaper;**
- **Works would be finished quicker with less disruption;**
- **They will result in significant improvement to the internal space in your home;**
- **They do not require consent from Planning;**
- **They do not require your neighbour's approval;**
- **They would generate less carbon compared to a new structure, given the reduced amount of materials required.**



Photo 40

INTERNAL LAYOUTS

The position and type of furniture is also an important factor in shaping the internal space of your home, which could make it more spacious or more restrictive.

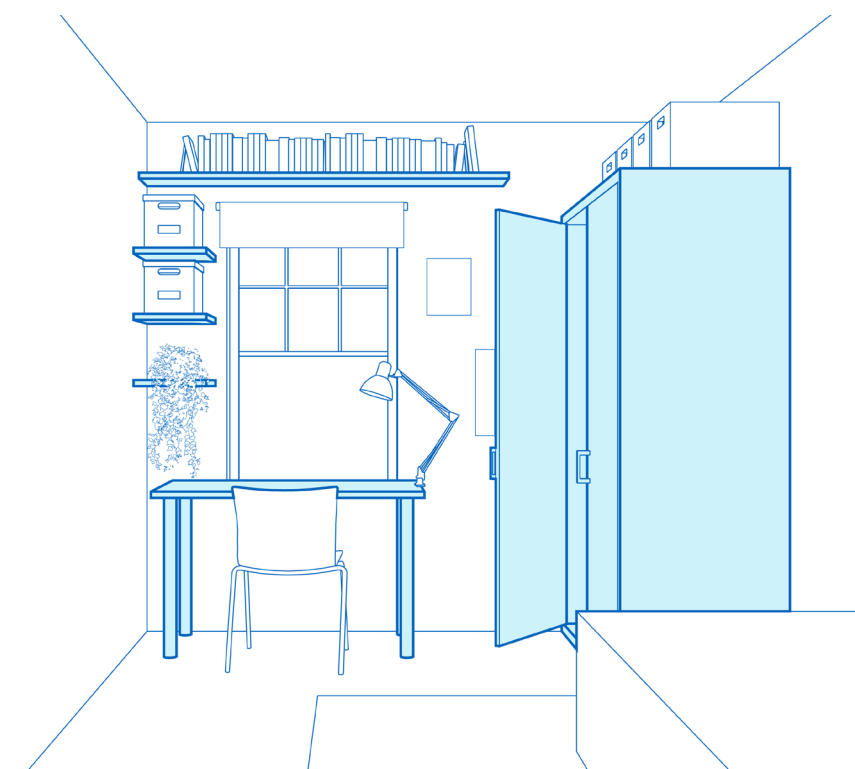

- Furniture
- Location of shelves
- Lighter wall colours reflect more light internally

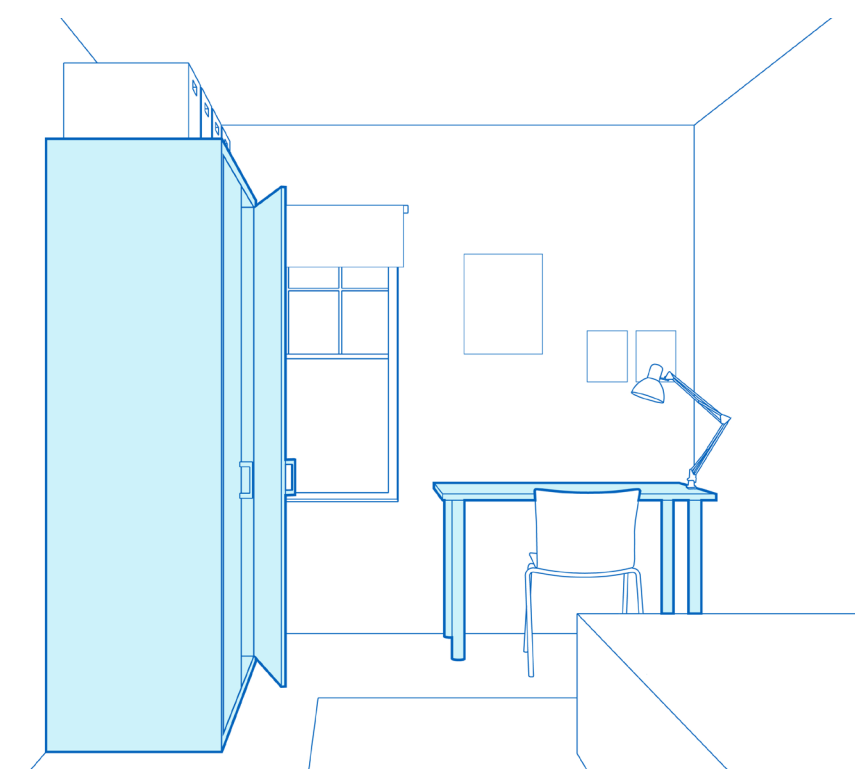
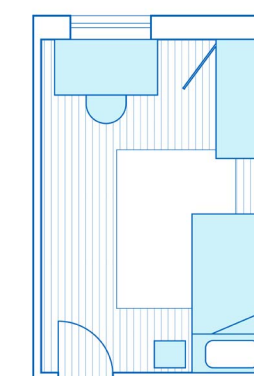

- Furniture
- Location of shelves
- Lighter wall colours reflect more light internally

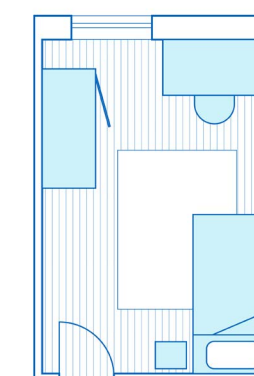

4.1 INTERNAL LAYOUTS

Below there are two scenarios with internal alterations on a late Victorian house built around 1876-99. The historic plans show internal division of rooms similar to a modern layout, but accessed through thin corridors and restrictive door openings.

The options show internal alterations which would make the dwelling accessible and adaptable for future needs and generations.

VICTORIAN BUILDING 1876-99

EXISTING PLANS

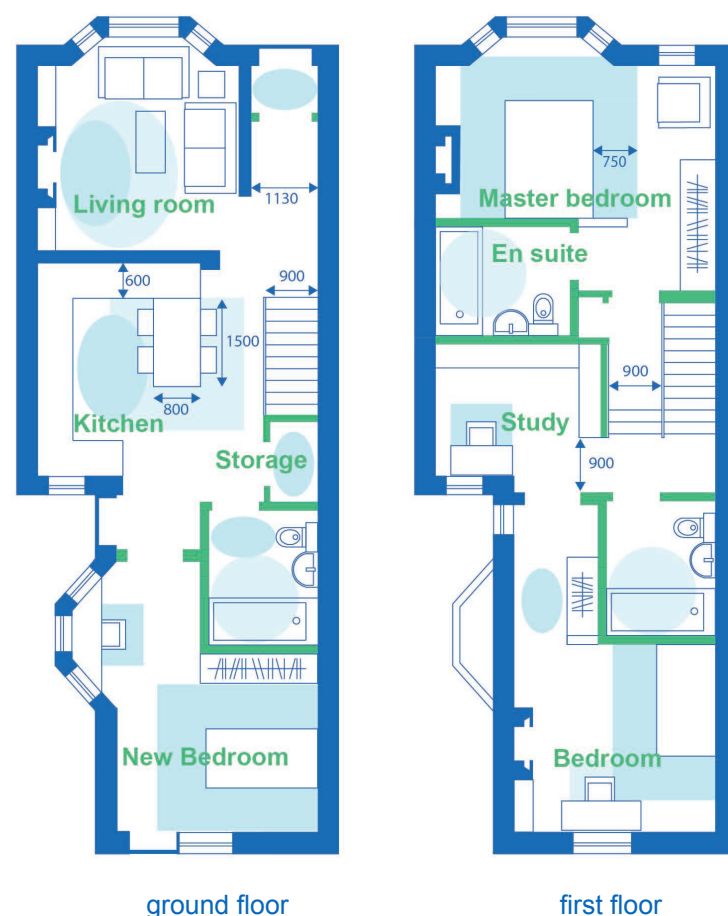

Photo 41



Photo 42

SCENARIO 1



A young couple lived in Camden for the last ten years, in a Victorian house in a Conservation Area. They have one child and together they managed to live in this house without doing any changes to the historic layout, except for adding some modern fittings and furniture.

An elderly relative who has mobility problems and can't handle stairs, now seeks to move in with them. Their jobs also require them to work from home more, so they need a new desk space. In response to the change in circumstances, the couple could only afford to do internal changes to the existing layout:

Ground floor

- Enlarged porch area to allow better dressing space, which also helps with draught proofing
- Relocation of kitchen in the reception room and removal of some partition walls

- Larger storage space
- New bathroom for all members of the family
- New bedroom at the rear of the ground floor level
- Replace the staircase balustrade to enlarge the steps width

First floor

- Enlarged circulation space
- New en-suite to the master bedroom and storage space
- Relocation of the bathroom
- Enlarged existing bedrooms
- New study room to enable work from home

The internal layout now works for all members of the family and they will enjoy living here for many years to come.

SCENARIO 2

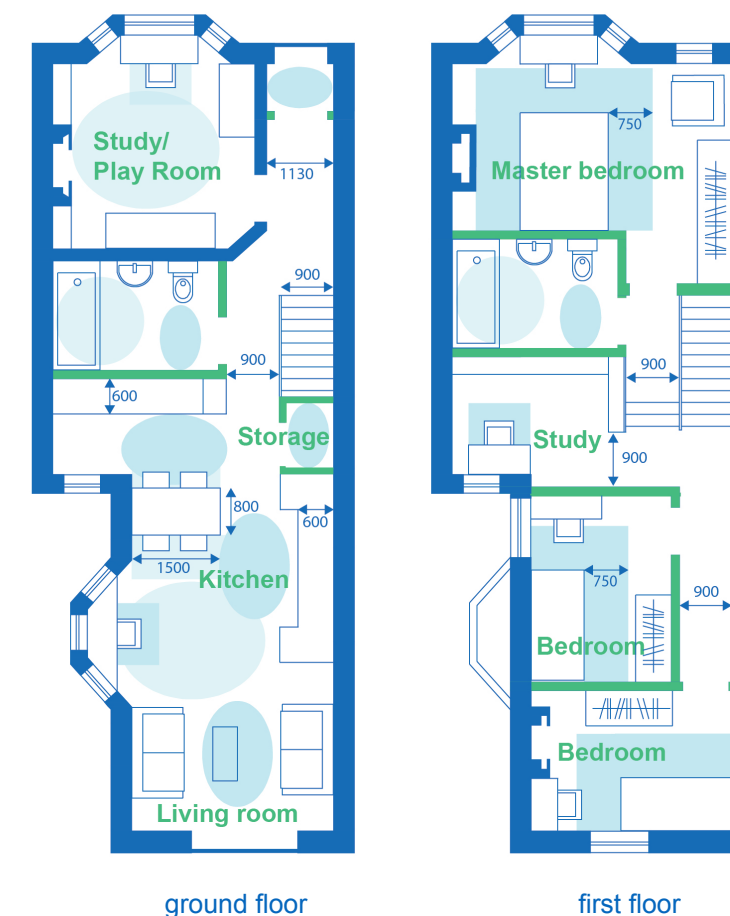

A couple have bought a Victorian house in a Conservation Area in Camden. The internal layout of the house still shows the way Victorians lived but this does not work for them.

They have one child and soon expecting their second. Their jobs require them to work from home and until now they were using the spare bedroom as a study. As their circumstances change, they can only afford to adapt the internal layout of the building, so they thought of the following:

Ground floor

- Enlarged porch area to allow better dressing space, which also helps with draught proofing
- New study and play room to the front room
- New bathroom to be accessed by all members of the family

- Kitchen relocated partially in the reception room and the rear room
- Larger storage space underneath the staircase
- Relocate the main living space at the rear with direct access to the garden
- Replace the staircase balustrade to enlarge the steps width

First floor

- Enlarged circulation space
- Relocation of the bathroom to be accessed by all
- New second study room
- Relocation of bedroom

The internal layout now works well for the new extended family.

5. GARDENS

The gardens of Camden’s urban townscape provide an extremely important asset to the Borough’s attractiveness and character. They also contribute to the setting of individual buildings and Conservation Areas. There are many positive health outcomes both from taking part in gardening activities and from seeing trees and landscaping as a pleasant and healthier environment.

It is acknowledged that not everyone in Camden has access to a garden, but for this particular reason those who have should be mindful of the benefits that private front and rear gardens can bring to the wider community.

If you consider planting new trees in your garden, there are certain considerations you should take into account - See Greenery and Biodiversity in Sustainability Chapter and CPG Trees for detailed information about this at para 3.9.



Photo 43

Why are gardens important?

- They form part of the semi-public domain as they are overlooked from adjacent buildings and the streetscene and contribute greatly to the outlook of occupants;
- They contribute to the character of an area in terms of the relationship between buildings and spaces and the resulting openness or sense of enclosure;
- Play a significant role in maintaining the Borough’s green infrastructure and biodiversity. See [CPG Biodiversity](#);
- Groups of trees and vegetation along the rear boundaries of a garden, in particular, provide important wildlife corridors;
- They can provide a sense of the greenery along the street and where they can be viewed through gaps between buildings;
- They support trees and vegetation which assist with cooling, prevent soil erosion and increase the permeability of soil to air and water;
- They provide a sense of visual separation and privacy;
- They soften the impact of buildings and integrate them into their setting and wider area.

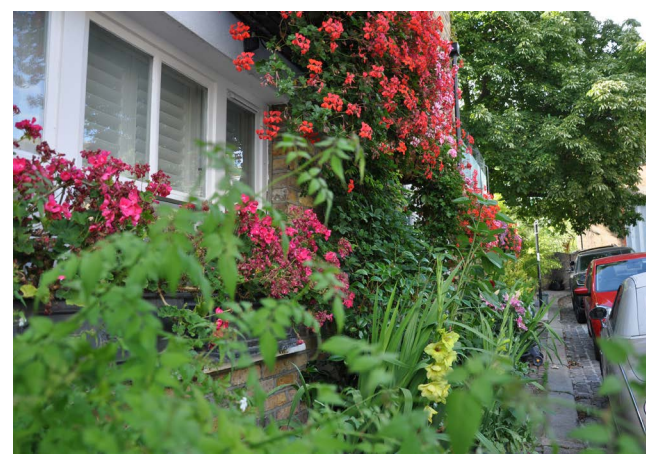

Photo 44

5.1 LANDSCAPING

Within the garden, landscaping could be soft landscaping (planting) or hard landscaping.

- Soft landscaping is a term used to describe the organic, vegetative or natural elements of landscape design. These natural elements could be permanent (grasses for lawns, other ground-cover plants, shrubs, climbers and trees) or transitory (herbs, annuals and biennials, perennials, and bulbous plants) which resume growth each year.
- Hard landscaping is a term used to describe the hard materials used in landscape design such as paving, seating, water features, lighting, fences, walls and railings.

For more information about landscaping see [CPG Design](#) and [CPG Biodiversity](#).

Before you consider altering your garden be mindful of the following considerations:

Grass and other ground covers:

- Can reduce air temperature by absorbing solar radiation and encouraging cooling by evaporation
- Aid in stabilizing soil embankments and preventing erosion
- Increase the permeability of soil to air and water
- Discourage the use of artificial lawns as they comprise of unsustainable materials and lack any biodiversity value

Trees are best at:

- Providing shade,
- Serving as windbreak, defining space
- Directing and screening views
- Attenuating sound
- Improving air quality
- Stabilising soil

In order to ensure the longevity of the plants and trees in your garden, there are some factors to consider in the selection and use of plant materials in landscaping to include:



Tree structure and shape



Seasonal density, texture and colour of foliage



Rate of growth



Mature height and spread of foliage



Requirements for soil, water, sunlight and temperature range



Depth and extent of the root structure



CONSIDERATIONS

- | | |
|---|--|
| <ul style="list-style-type: none"> 1. Vertical Greening 2. Green Roof 3. Low boundary walls with hedges and trellis with climber plants 4. Varied species of shrubs, plans, and trees to support biodiversity | <ul style="list-style-type: none"> 5. Wildlife homes (bats and birds) 6. Gaps/holes in fences to support wildlife corridors 7. Green buffer with the street and the open space 8. Pond for wider biodiversity support 9. Open space |
|---|--|

5.2 FRONT, REAR & SIDE GARDENS

The design of gardens provides support to green and wildlife corridors and makes a significant impact to the character and attractiveness of an area, particularly important to the streetscene,

Gardens have become particularly prone to development pressures where the loss of soft landscaping has resulted in the erosion of local character, amenity, biodiversity and their function as a sustainable drainage system to reduce local storm water runoff.

If your garden already has hardstanding which you are looking to replace due to damage, you should consider maximising the soft landscaping areas and provision of permeable surfaces, to allow water to runoff, grasses to grow and generally support a more biodiverse and resilient soil.

Make your home super-wildlife friendly

A pond is a haven for various types of plants, insects, birds and animals. A pond provides essential drinking and bathing water for birds and mammals. At the rear of the property, if the space allows, you could integrate a pond into the landscaping of your garden. If you plant a range of plant species around the edge of the pond, this would support an even greater diversity of wildlife. You can find more information about this on [RSPB website](#)

Always consider maximising the areas of soft landscaping over hard landscaping.

For homes in Conservation Areas, if you want to remove or trim a tree in your garden with a trunk diameter of 75mm or more, you will need to apply for Prior notification of the tree works. See [CPG Trees for more info.](#)



Photo 45



When you design alterations to your **garden** or other similar forecourt spaces, you should:

- Consider maximising areas for soft landscaping over hard landscaping, which should be permeable if proposed;
- Prioritise retention of existing permanent elements as they are important for sustaining biodiversity in your garden: trees and shrubs provide cover for nesting birds and bats, as well as rich food sources;
- When selecting plants, their biodiversity is a key consideration. In general, native plants are best chosen followed by near natives and then exotics which can extend the flowering season and provide an added resource later in the year for some types of insects, such as solitary bees. Overall, the differences between these categories are not large, and plenty of wildlife will be supported by all three.
- For front gardens, hard surfaces should cover no more than 30% of your garden and they should be properly designed to provide access to and from your home, with considerations for elderly, wheelchair users, and pushchairs;

If in a Conservation Area and you are planning to extend your property with a structure which incorporates new foundations in close proximity to an existing tree, you will need to provide an [Arboricultural Impact Assessment](#) as part of your submission for planning permission to extend.

- For rear gardens you are advised to consider permeable surfaces for patio areas or raised timber boards which would allow the soil to continue living underneath;
- Retain trees and mature vegetation which contribute to the biodiversity and character of the site and surrounding area;
- Maintain dark corridors to the rear and sides of the garden and be mindful of the impact of artificial light on wildlife;
- Integrate planting into garden structures, e.g. bin and bike stores – see details below
- Retain or re-introduce original surface materials and boundary features, such as decorative paving, walls, railings and hedges where they have been removed, especially in Conservation Areas. Any new materials should be complementary to the host building and neighbouring ones.

On-site parking is limited to spaces designated for disabled people where on-street parking is not possible. The Council will not support development of boundary treatments and gardens to provide vehicle crossover and on-site parking due to the impact on green infrastructure, biodiversity and character of the area. The Council encourages sustainable modes of transport. For further information see [CPG Transport](#)

5.3 BOUNDARY TREATMENTS

Boundary treatments are one of the most prominent elements of your home within the streetscene. The way the boundary relates to your home and neighbouring ones has a strong contribution to the character of your property, its appearance, and wider area.

It is important that before engaging in changing the boundary of your home you should firstly establish if your home is in a Conservation Area covered by Article 4 directions which can restrict alterations to boundary treatments under permitted development. If the answer is yes, you will need to submit an application to the council with your proposal.

If your property benefits from permitted development rights (it is a single family dwelling and not covered by Article 4 directions) then you can erect a boundary fence up to 1m if height in facing a highway, or under 2m along any other boundary. Height is measured from natural ground level and should include any additional structure you may wish to attach to the top, such as a trellis.



Photo 46



If you are planning to make changes to your home's **boundary treatment** you should be aware that:

- We would expect that the repair of boundary walls, fences and railings are considered before they are replaced;
- We would expect that its dimensions, proportions, detailing and design respect the existing character of the street and is subordinate to the host building;
- Materials used should relate and complement the host building and we would encourage the incorporation of planting along railings;
- In Conservation Areas, check the Conservation Area Appraisal in relation to boundary treatments. The works should preserve or enhance the existing qualities and context of the site, and character of the Conservation Area;
- Consider gaps in boundary treatments in order to ensure wildlife could still move through gardens to find needed food, by removing bricks from the wall, cutting a hole in the fence, digging a tunnel underneath the fence, or leaving a gap at each side of the boundary wall. This is especially important for hedgehogs, which travel on average a mile a day and they are currently in a rapid decline;
- The design and construction does not damage any trees within the curtilage of the property or those in close proximity that may have their root system running into your curtilage;
- Consider installation of bird and bat boxes on the structure or in vicinity.

All garden gates and doors should not open outwards into the public highway

5.4 GARDEN STORAGE

The increased need for storage in everyday lives could put significant pressure on the natural environment if located outside. Garden storage facilities if not designed carefully, could take over garden areas which could have been better used by plants, shrubs, trees and wildlife.

To make your home wildlife friendly, plant nectar rich plants which would attract insects and birds.



BICYCLES AND BINS STORAGE

If your structure to accommodate garden storage takes up garden space, you are encouraged to consider provision of a green roof on top of your garden storage structure. Consider an adequate substrate (soil) depth of 100mm or more and drainage for your green roof to allow plants to grow and mature easily whilst requiring lower maintenance.

When designing structures for your garden for bicycles and bins, you should be mindful of the possibility of requiring additional storage area in the future, such as plant equipment, space for pushchairs or water harvesting.

There are ways to accommodate adequate storage for your home, while also caring for the environment. We encourage innovative solutions which can incorporate wildlife habitats.

WATER HARVESTING

If you want to make your home more environmentally friendly you can consider installation of water butts in order to harvest the rainwater which you could then use to water your plants in pots and garden.

Water butts come in different shapes and forms and they are generally located adjacent to the side of your building where your downpipes are, away from the street.

You can integrate the water butt and cladding or trellis with pots around to allow plants to grow on it.

Water butts in your garden are not considered development that requires planning permission.



Photo 47



Photo 48



Photo 49



Photo 50

5.5 OUTBUILDINGS



Outbuildings are structures within a property's garden which offer a reasonably low-cost alternative to an extension, whilst providing usable space away from the main building for various functions such as storage, home office, studio, gym, children's playroom etc. They can free up space in the main dwellinghouse to allow for an extra bedroom, kitchen or living area, without the need for an extension. The outbuilding could be in the form of a shed, greenhouse, or others.

As they occupy space in the garden, the size and design of outbuildings must consider their impact on the amenity of neighbouring occupiers, biodiversity and character of the wider area, so they do not detract from the generally 'soft' and green nature of gardens and other open spaces.

Large garden buildings may affect the amenity value of neighbours' gardens, and if used for purposes other than storage or other domestic uses, may intensify the use of garden spaces and cause loss of amenity through overlooking, overshadowing, lightspill and noise nuisance.

To result in an acceptable scheme, **development in rear gardens** should:

- Ensure the siting, location, scale and design has a minimal visual impact on, and is visually subordinate within, the host garden;
- In Conservation Areas, check the Conservation Area Appraisal in relation to outbuildings, to know what you should consider. The works should preserve or enhance the existing qualities and context of the site, and character of the Conservation Area;
- Not detract from the open character and garden amenity of neighbouring gardens and the wider surrounding area;
- Retain space around the building for suitable soft landscaping;
- Ensure the height will retain visibility over garden walls and fences;
- Ensure the size will maximise retention of garden and amenity space;
- Ensure the position will not harm existing trees and their roots;
- The construction method should minimise any impact on trees, mature vegetation (see [CPG Trees](#)) or adjacent structures;
- Use materials which complement the host property and the overall character of the surrounding garden area;
- Consider installation of green roof and/or solar panels;
- Address any impacts upon water run-off and groundwater flows, and demonstrate that the impact of the new development will be negated by the measures proposed. Reference should be made to [CPG Water and Flooding](#).
- Consider installation of water butts;
- Consider installation of bird and bat boxes on the structure or in vicinity.

Outbuildings are permitted under Class E of GPDO 2016 for single family dwellings, not covered by Article 4 Directions in a Conservation Area.

The use of outbuildings should always be incidental to the enjoyment of the main house. The use of an outbuilding as a self-contained (independent) residential accommodation would be subject to enforcement action if undertaken without planning permission specifically for this use.

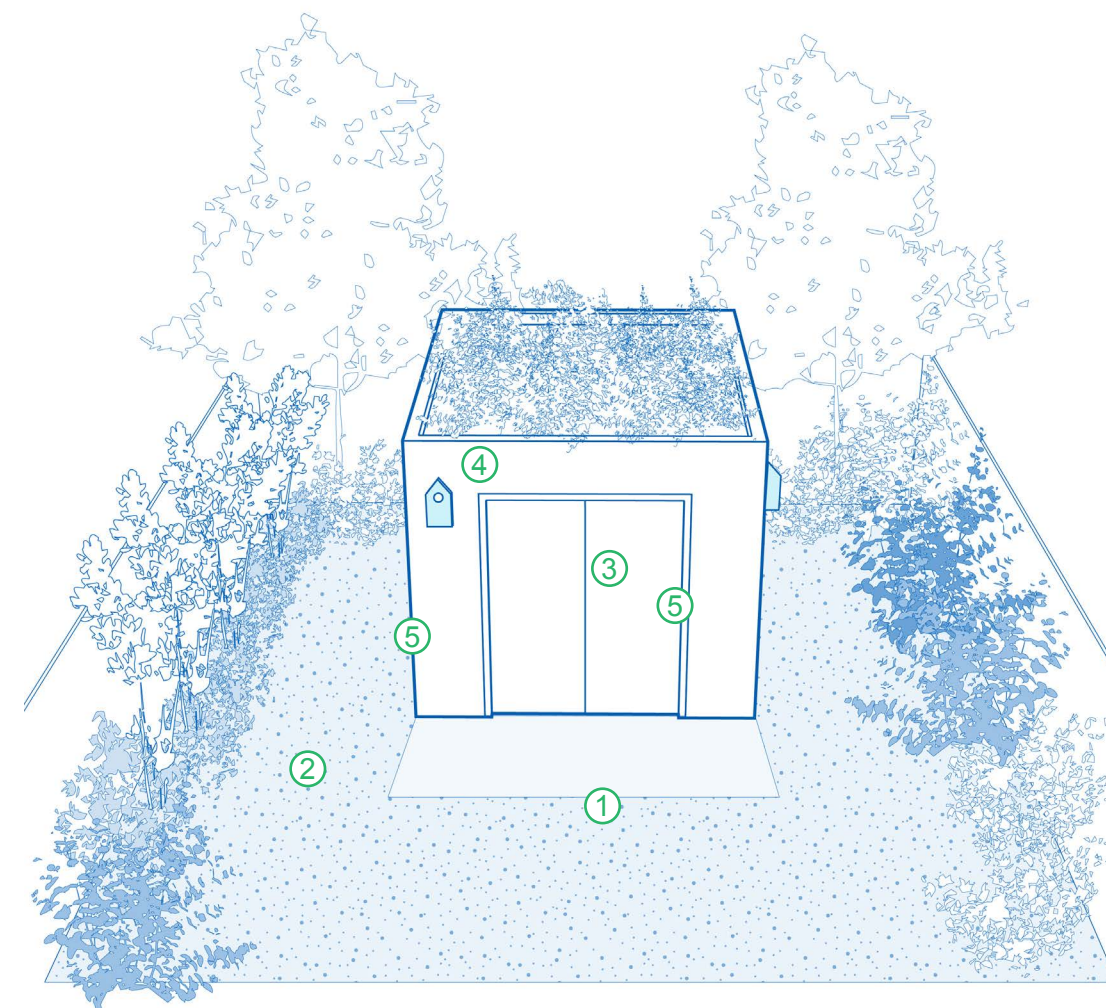

1. Structure subordinate to the garden size
2. Maintain adequate distance to boundaries to allow plants to grow
3. Overall domestic character and appearance
4. Green roof as insulator and support of biodiversity
5. Bird / bat box to support biodiversity

APPENDICES

APPENDIX 1

HOME ENERGY EFFICIENCY MEASURES

MEASURE	COST/PAYBACK	IMPROVEMENT	DISRUPTION
Loft insulation	£	↗ ↗ ↗ ↗	⚠
Pipes/boiler tank insulation	£	↗ ↗ ↗	⚠
Draught proofing	£	↗ ↗	⚠
LED lighting	£	↗ ↗	⚠
Cavity wall insulation	£ £	↗ ↗ ↗ ↗	⚠
Room in roof insulation	£ £	↗ ↗ ↗ ↗	⚠ ⚠ ⚠
Internal wall insulation	£ £ £	↗ ↗ ↗ ↗	⚠ ⚠ ⚠ ⚠
Floor insulation	£ £ £	↗ ↗ ↗ ↗	⚠ ⚠ ⚠
Solar PV (electric)	£ £ £	↗ ↗ ↗	⚠
Upgrading windows / new windows (single to double glazing)	£ £ £	↗ ↗	⚠ ⚠
Ground source heat pump	£ £ £ £	↗ ↗ ↗ ↗	⚠ ⚠ ⚠ ⚠
Air source heat pump	£ £ £	↗ ↗ ↗	⚠ ⚠ ⚠
External wall insulation	£ £ £ £	↗ ↗ ↗ ↗	⚠ ⚠ ⚠

Cost/payback



Improvement level



Disruption



£ £ £ £ = high £ = low

£ £ £ £ = £10k +

£ £ £ = £5k-10k

£ £ = £500-5k

£ = less than £500

All development (including extensions) are required to consider sustainable development principles from the start of the design process and include these in their Design and Access Statement. A simple checklist of measures is provided below which you can submit with your planning application to demonstrate what you have considered.

MEASURE	CONSIDERED Y/N	INCLUDED? SPECIFICATION
Loft insulation		
Pipes/boiler tank insulation		
Draught proofing		
LED lighting		
Cavity wall insulation		
Room in roof insulation		
Internal wall insulation		
Floor insulation		
Solar PV (electric)		
Upgrading windows/new windows (single to double glazing)		
Ground source heat pump		
Air source heat pump		
External wall insulation		

APPENDIX 2

PHOTO GLOSSARY

- 1, 2, 3, 4, 5, 6: Various Areas in Camden
- 7: Rear elevations on terraced houses in Camden
- 8: Solar panels well placed
- 9: Green roof part of rear extension. Tonkin Liu Architects. Alex James Photography
- 10: Bat box example from Bat Conservation Trust
- 11: Bird box exemplified from RSPB
- 12: Homemade bug hotel from RSPB
- 13: Brick, lead and metal window frames. Pardon Chambers Architects. Caroline Mardon Photography
- 14: Brick, metal, timber. Richard Keep Architects
- 15: Timber and stone. Hayhurst & Co. Architects. Kilian O'Sullivan Photography.
- 16: Red brick flank wall with decorative chimney breast and stack.
- 17: Rear extension. Whiteman Architects
- 18: Rear extension. Pardon Chambers Architects. Caroline Mardon Photography
- 19: Rear extension. DF_DC architects. Rory Gardiner Photography
- 20: Good examples of side extensions.
- 21: BingMaps aerial view in Camden showing front and rear dormers.
- 22: Good examples rear dormers
- 23: Good example of front dormers
- 24: Bad example of rear dormer
- 25: Good example of side dormer
- 26: Good example of rear dormer
- 27: Mansard extensions in valley roofs. Good and bad examples.
- 28: Good example of mansard extensions
- 29: Roof extensions. Richard Keep Architects.
- 30: Modern Balcony. Richard Keep Architects.
- 31: Single glazed window and bad example of double glazed with thick frames in UPVC material, with stuck-on glazing bars.
- 32: Good example of double glazed timber sash window
- 33: Bad example of double glazing in UPVC material with stuck-on glazing bars
- 34: Timber, brick and stone. Architecture for London, photo by Christian Brailey.
- 35: Natural stone. Architecture for London. Christian Brailey Photography
- 36: Good example of cast iron pipe
- 37: Bad example of cluttered front elevation with plastic pipes
- 38: Historic roof and features
- 39: Well positioned, proportionate rooflights
- 40: Storage and play area. DF_DC Architects. Rory Gardiner Photography
- 41: Front of Victorian home
- 42: Entrance of Victorian home
- 43: Green Front garden Camden
- 44: Green front garden Camden
- 45: Landscaped front garden with flowers, herbs, vegetables, shrubs, birds and bugs boxes.
- 46: Front boundary wall Camden
- 47: Homemade structure to support greenery and biodiversity
- 48: Bins storage
- 49: Metal bike storage with green roof
- 50: Water Harvesting structure